

EN SKID PLATE KIT INSTALLATION MANUAL

DE MONTAGEANLEITUNG FÜR UNTERFAHRSCHUTZ

RU ИНСТРУКЦИЯ ПО УСТАНОВКЕ КОМПЛЕКТА ЗАЩИТ



For: BRC X-TERRA CT (2025-)

K.9501.1

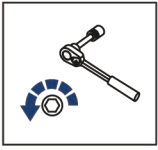

EN Regular fasteners
DE Werksseitige Schrauben verwenden
RU Штатный крепёж

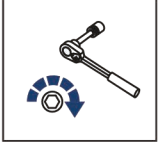

EN Regular fasteners
DE Werksseitige Schrauben verwenden
RU Штатный крепёж



EN Screw in by a few turns
DE Einige Umdrehungen einschrauben
RU Вкрутить на несколько оборотов



EN Loosen bolts
DE Bolzen lockern
RU Выкрутить на несколько оборотов

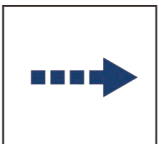



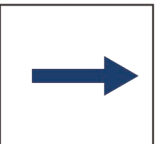

EN Movement Arrow
DE Bewegungsrichtung
RU Движение





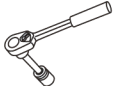





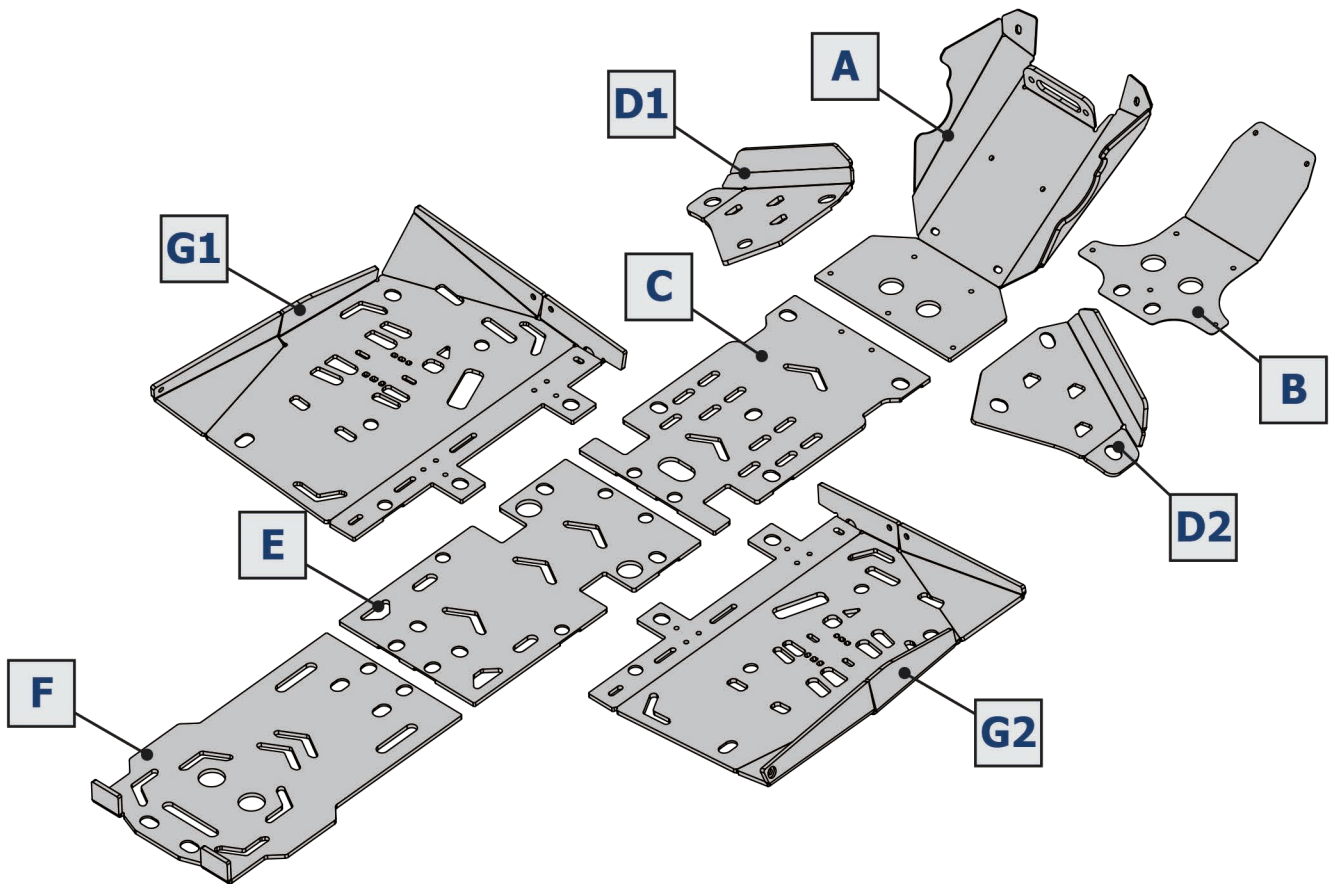

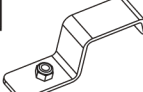

EN Location / Position Arrow
DE Anordnung/Position
RU Расположение

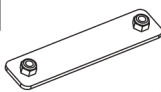
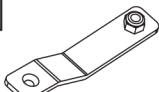
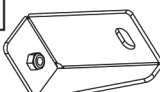
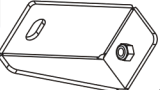
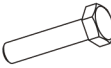
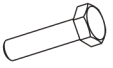
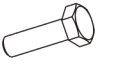
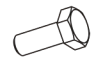
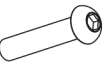
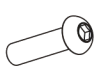
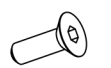
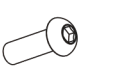

EN Screw Arrow
DE Drehrichtung
RU Поворот

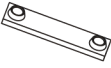
| | | | | |
|---|--|--|--|---|
|  EN Ratchet DE Ratsche RU Трещётка |  S - 10 |  HEX S - 5 |  EN Drill DE Bohrmaschine RU Дрель |  Ø 6 |
|---|--|--|--|---|



| | | | | | |
|---|--|---|--|--|---|
| 1  x4 | 2  x6 | 3  x1 | 4  x1 | 5  x2 | 6  x1 |
| 7  x1 | 8  M6x35 x2 | 9  M6x30 x13 | 10  M6x25 x20 | 11  M6x16 x14 | 12  M6x35 x2 |
| 13  M6x25 x2 | 14  M6x16 x15 | 15  M6x12 x6 | 16  Ø6 x45 | 17  Ø6 x28 | 18  M6 x16 |
| 19  M6 x17 | 20  M6x40 x8 | 21  x4 | 22  x4 | 23  x2 | 24  x3 |

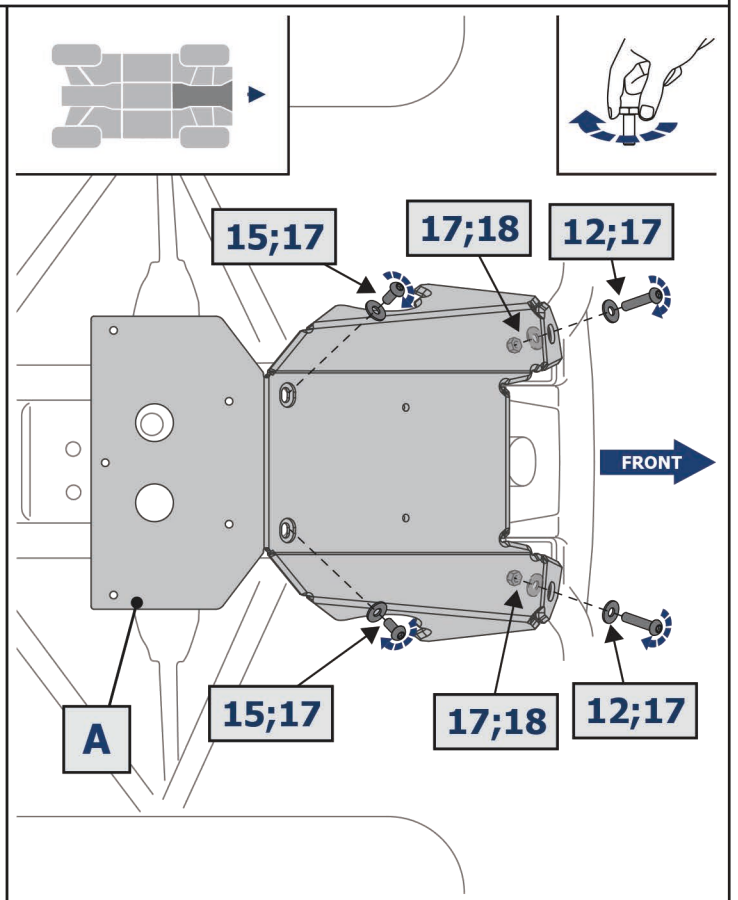
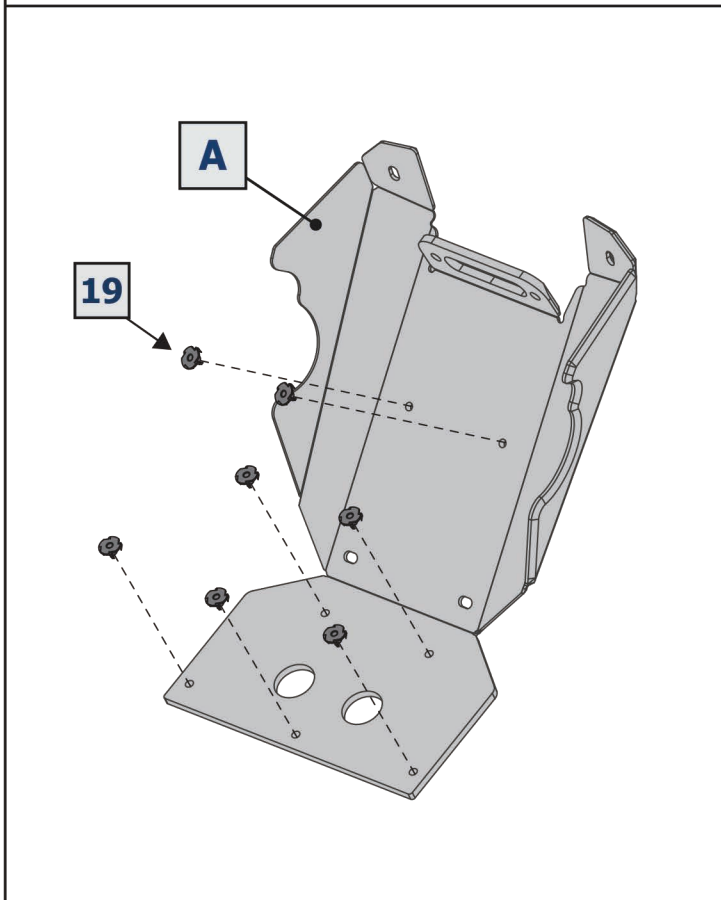
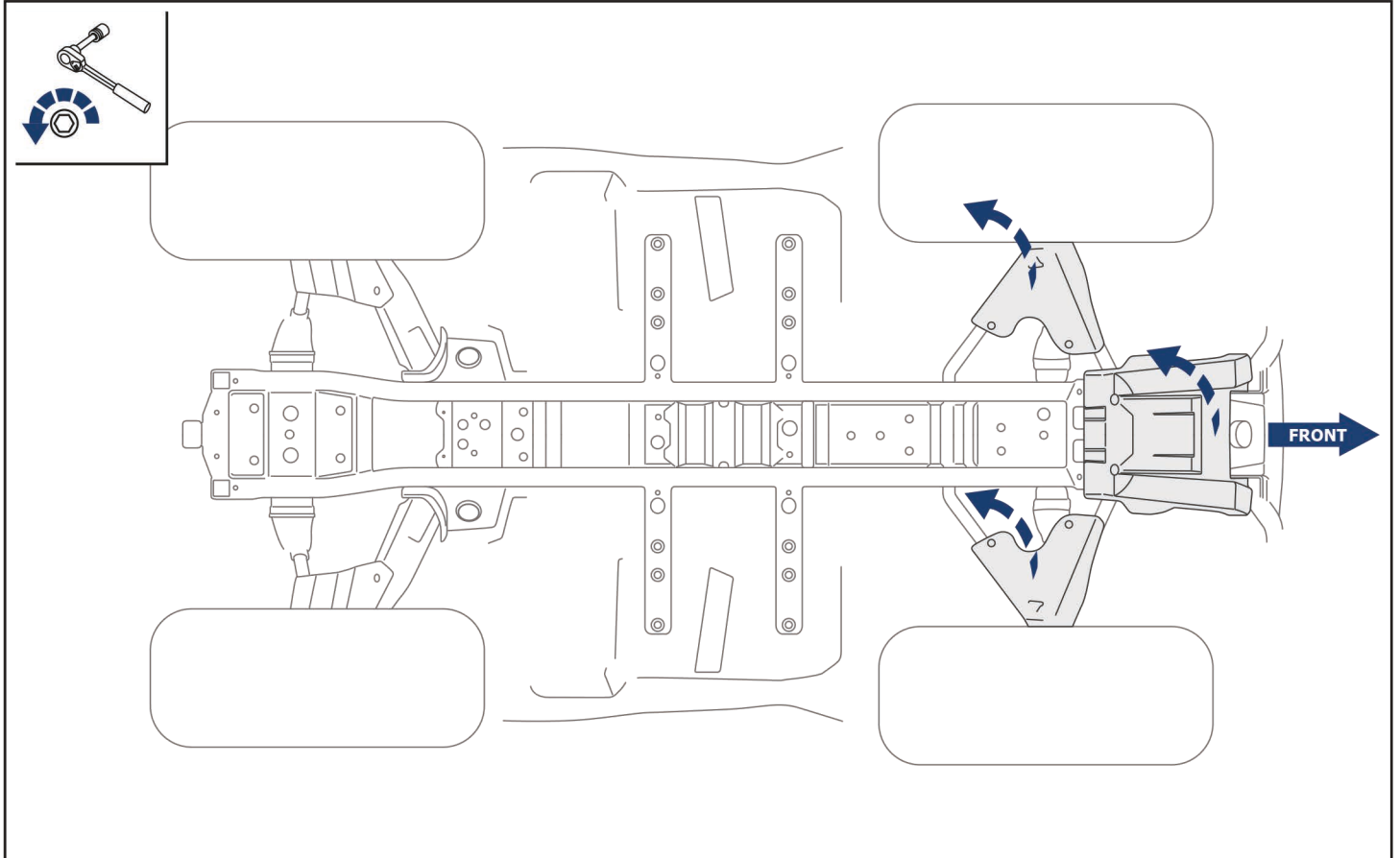

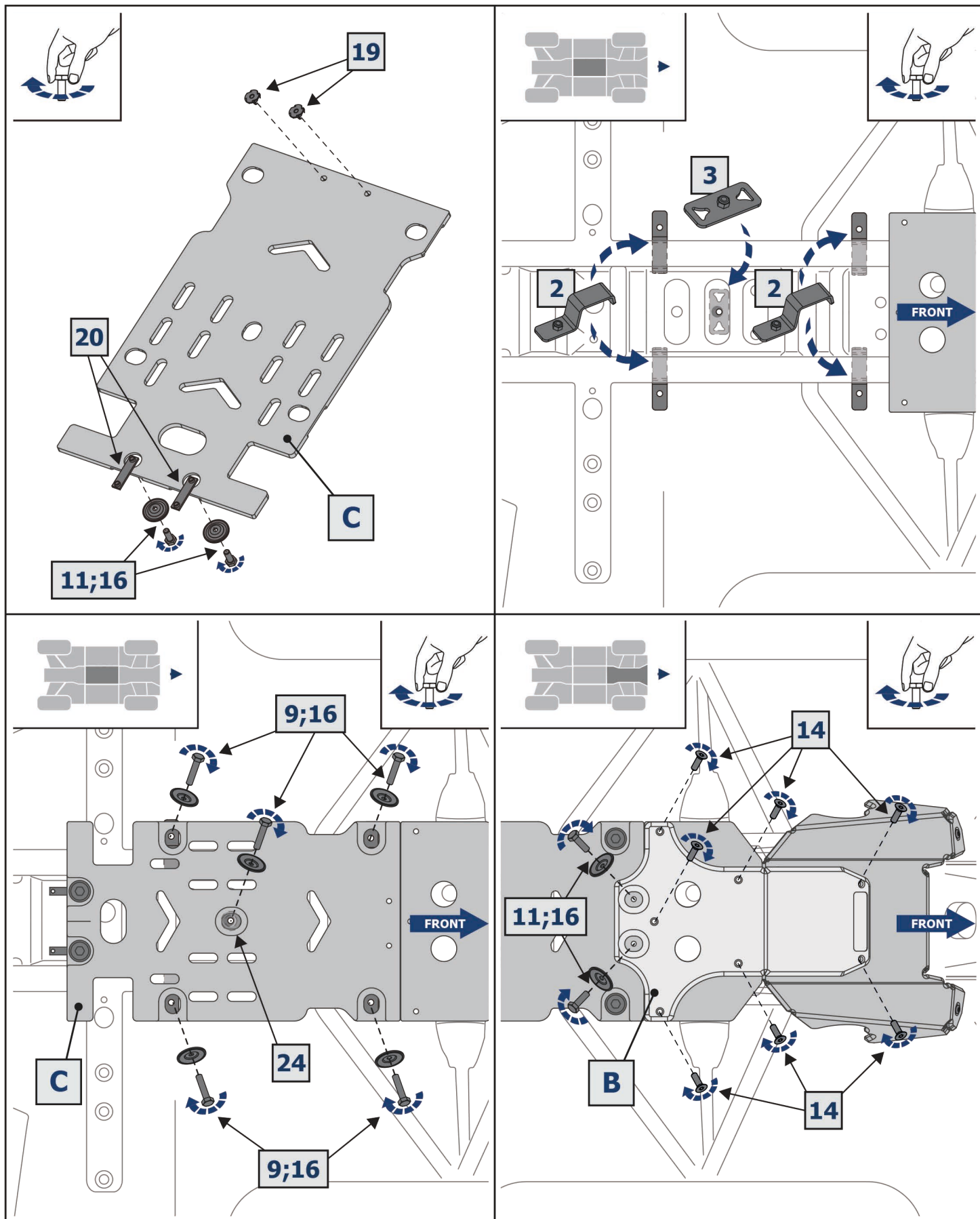

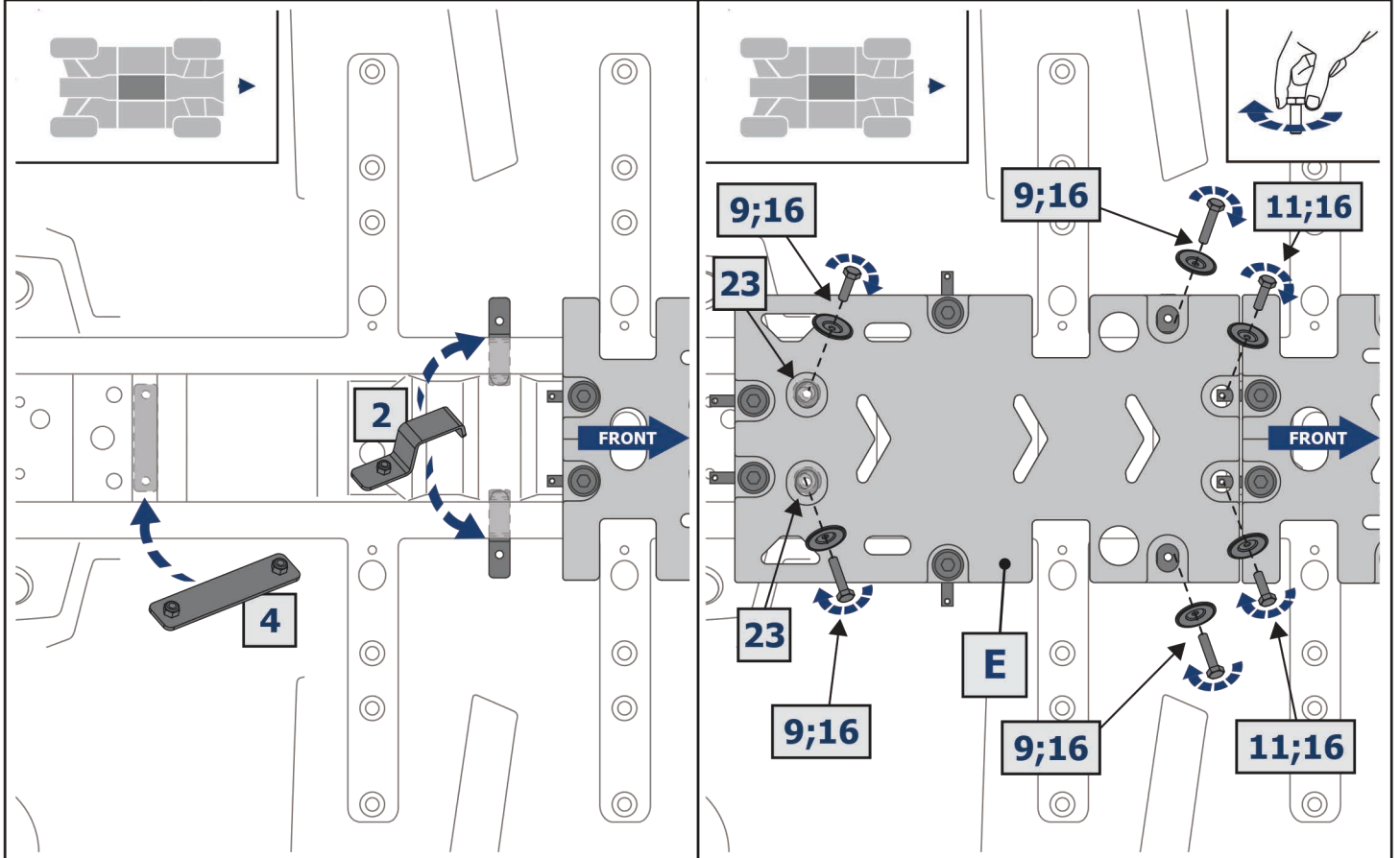
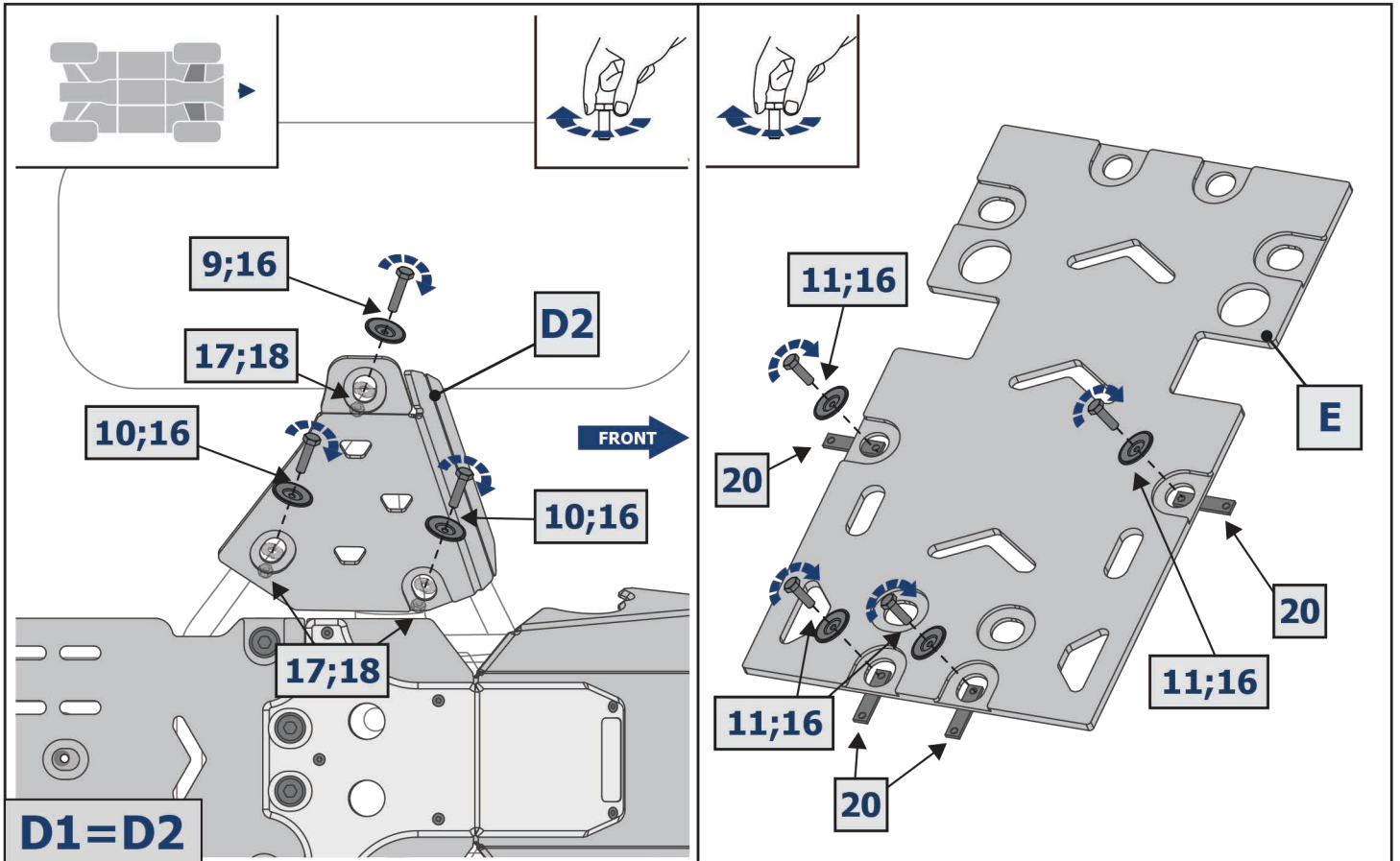

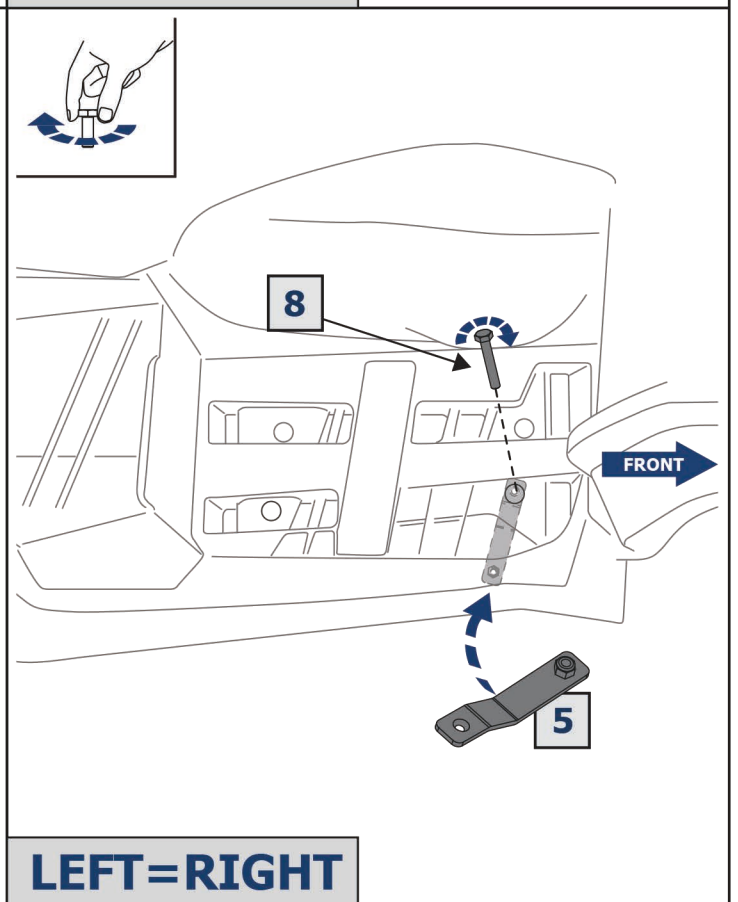
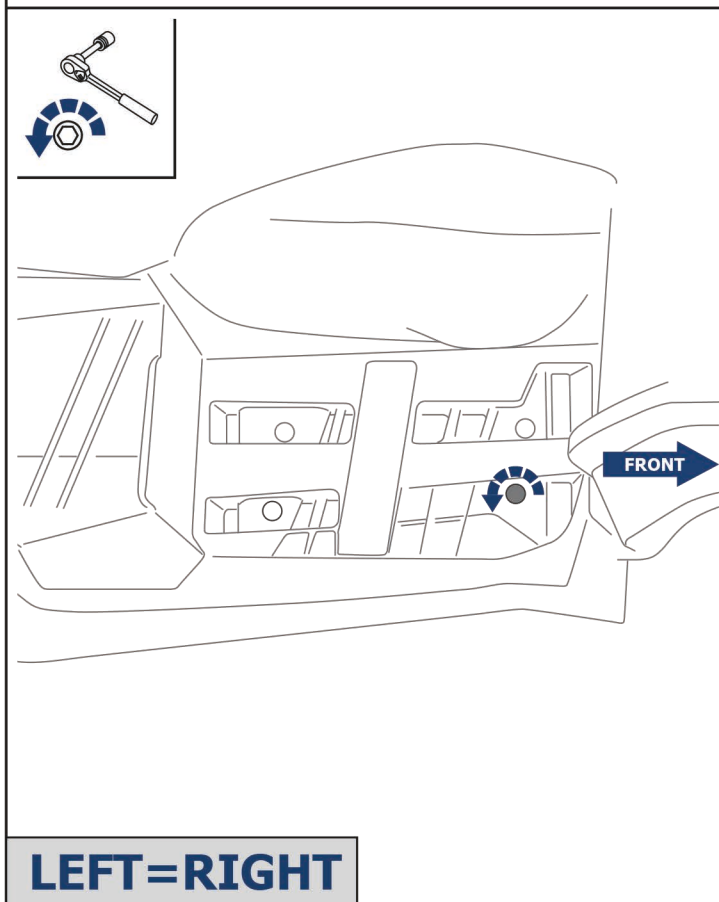
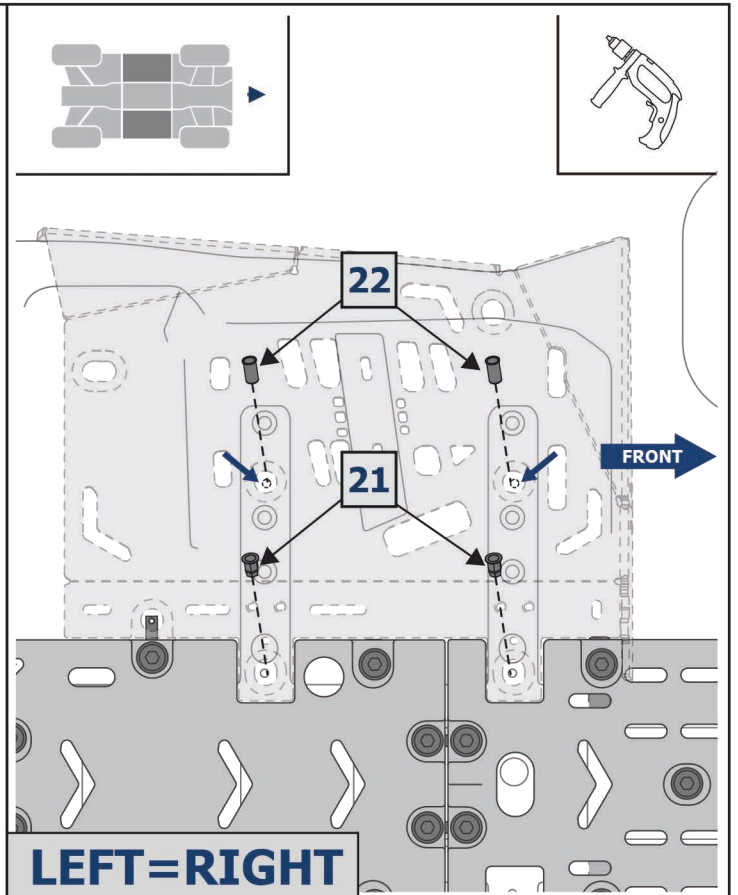
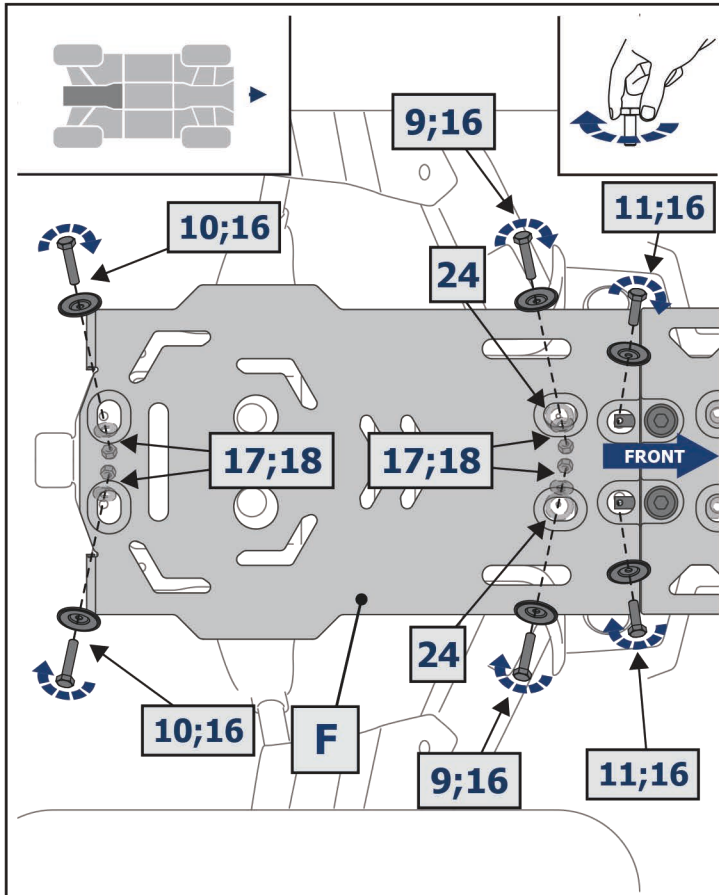

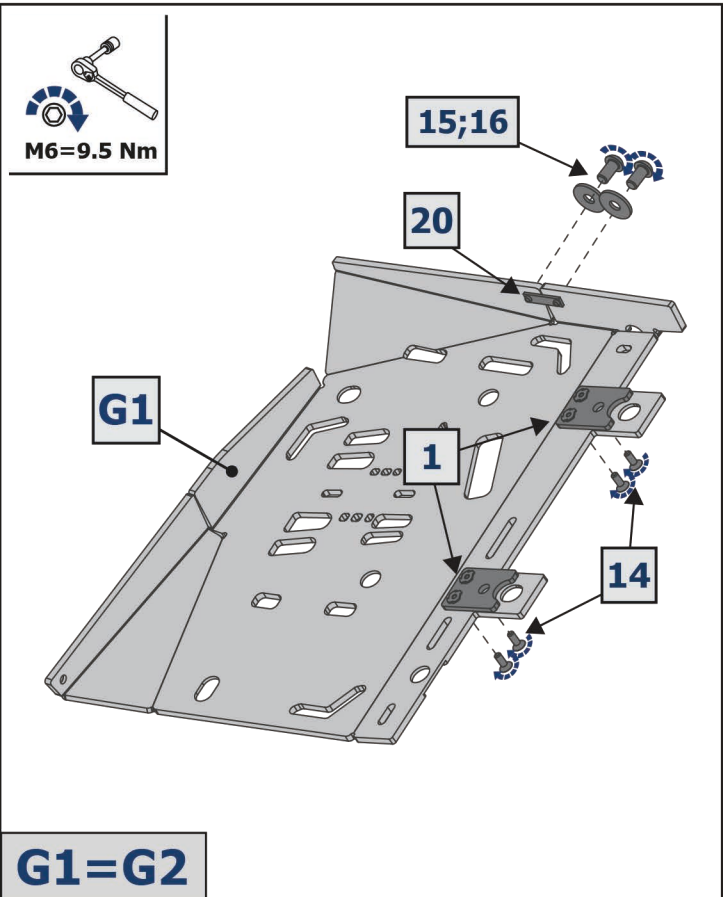
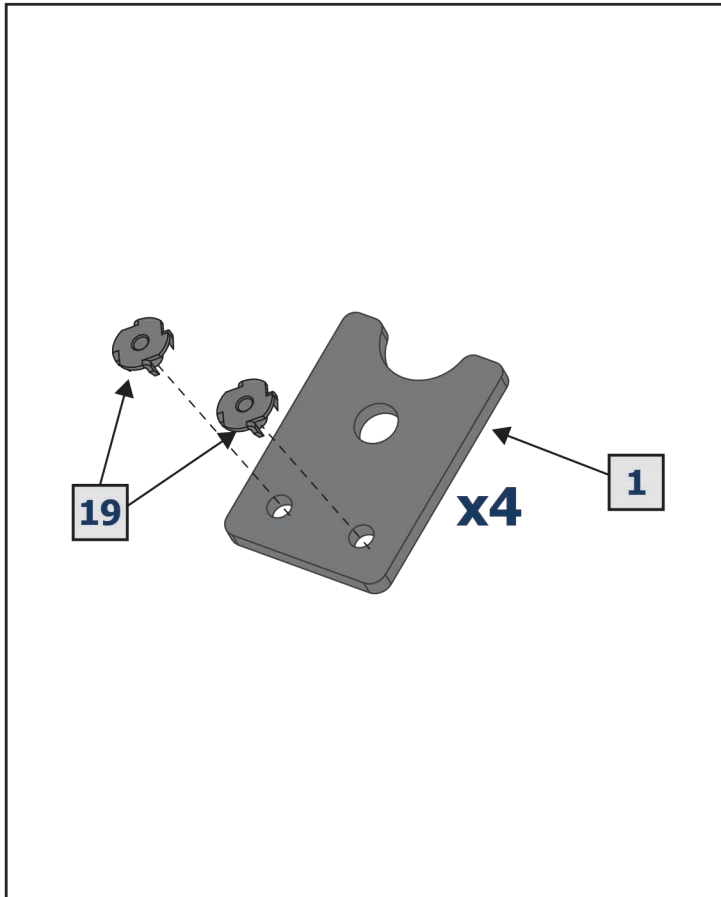

G1=G2

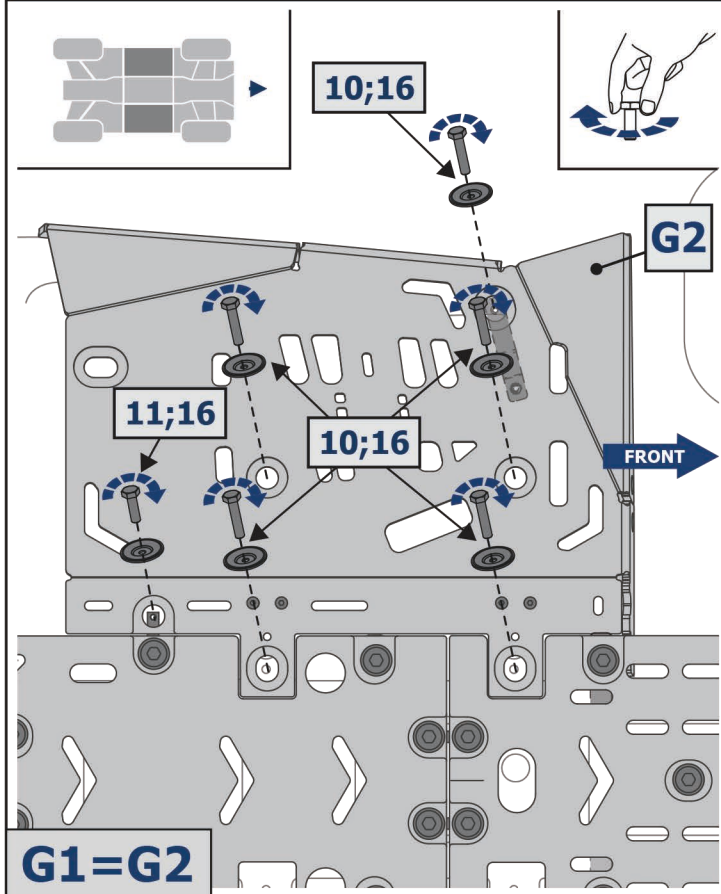

G1=G2

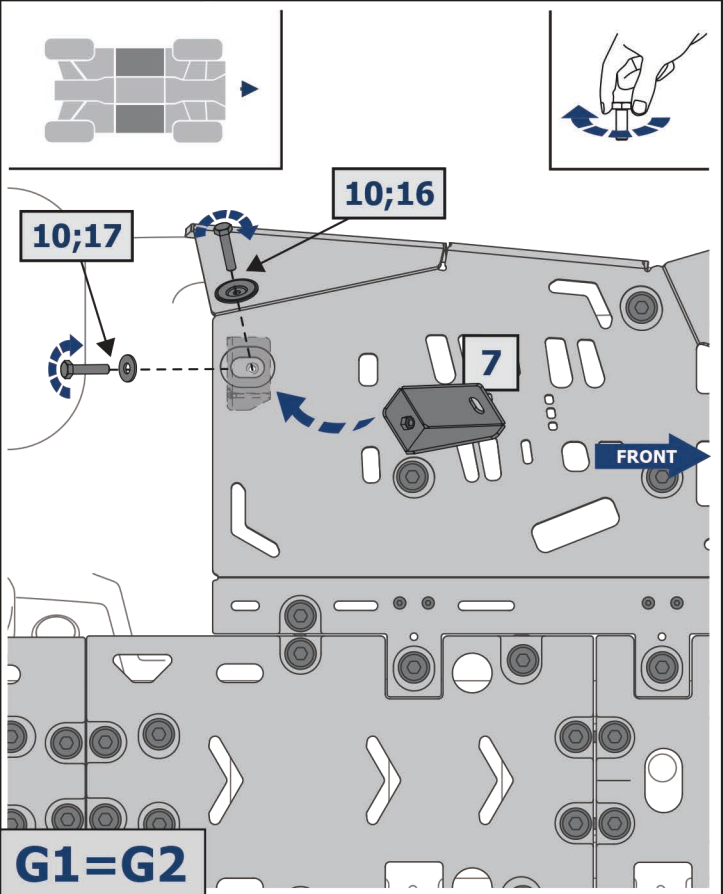

G1=G2

