

EN **SKID PLATE INSTALLATION MANUAL**

DE **MONTAGEEINLEITUNG FÜR UNTERBODENSCHUTZSYSTEM**

RU **ИНСТРУКЦИЯ ПО УСТАНОВКЕ КОМПЛЕКТА ЗАЩИТ**



**For: RM 800 DUO (2019-)**

K.7739.1;



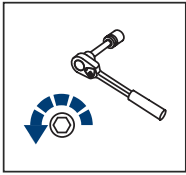

EN Regular fasteners  
DE Schraube herausdrehen  
RU Штатный крепеж

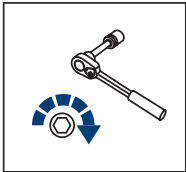

EN Regular fasteners  
DE Schraube eindrehen und festziehen  
RU Штатный крепеж

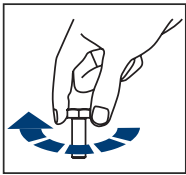

EN Screw a several turns  
DE Schraube wenige Umdrehungen eindrehen  
RU Вкрутить на несколько оборотов

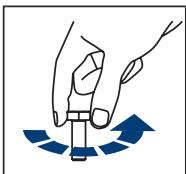

EN Loosen bolts  
DE Schraube wenige Umdrehungen lösen  
RU Выкрутить на несколько оборотов

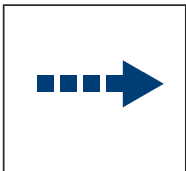

EN Movement Arrow  
DE Bewegungsrichtung  
RU Движение

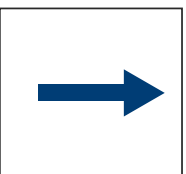

EN Location/Position Arrow  
DE Blickrichtung / Postionsrichtung  
RU Расположение



EN Screw Arrow  
DE Drehrichtung  
RU Поворот

	EN Ratchet DE Ratsche RU Трещётка		S - 10; S - 13		HEX S - 4;		EN Office Knife DE Büromesser RU Канцелярский нож
--	---	--	-------------------	--	---------------	--	---

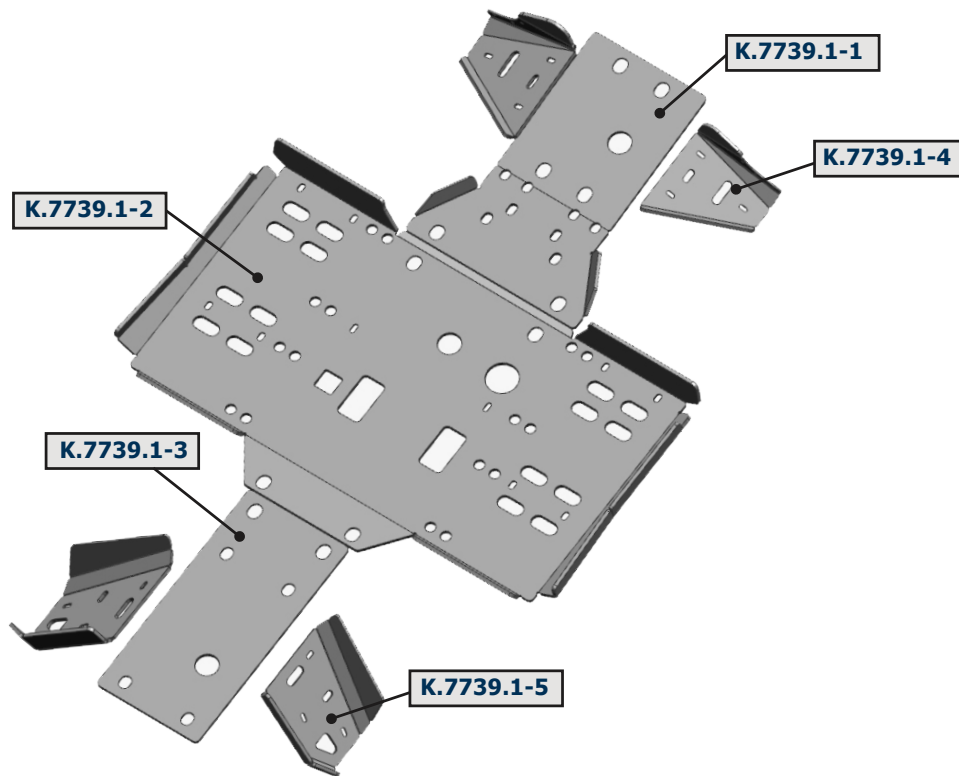

<b>1</b>  x6	<b>2</b>  x2	<b>3</b>  x2	<b>4</b>  x6	<b>5</b>  M6x16 x6	<b>6</b>  M6x16 x8
<b>7</b>  M6x20 x14	<b>8</b>  M8x25 x18	<b>9</b>  ø6 x20	<b>10</b>  ø6 x6	<b>11</b>  ø8 x10	<b>12</b>  ø6 x10
<b>13</b>  ø8 x8	<b>14</b>  M6 x6	<b>15</b>  x1	<b>16</b>  x1		

**SCREW FORCE:**  
M6 - 10 Nm; M8 - 30 Nm

