

**EN FRONT BUMPER INSTALLATION MANUAL**

**DE MONTAGEANLEITUNG FÜR FRONTBUMPER**

**RU ИНСТРУКЦИЯ ПО УСТАНОВКЕ ПЕРЕДНЕГО БАМПЕРА**



**For: Baltmotors Striker 500/700 EFI (2023-)  
STELS Leopard 600 (2014-)**

444.8546.1

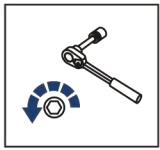

**EN Regular fasteners**  
**DE Werksseitige Schrauben verwenden**  
**RU Штатный крепёж**

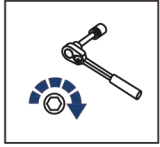

**EN Regular fasteners**  
**DE Werksseitige Schrauben verwenden**  
**RU Штатный крепёж**

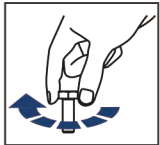

**EN Screw in by a few turns**  
**DE Einige Umdrehungen einschrauben**  
**RU Вкрутить на несколько оборотов**



**EN Loosen bolts**  
**DE Bolzen lockern**  
**RU Выкрутить на несколько оборотов**

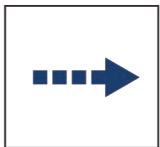

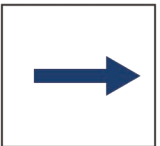

**EN Movement Arrow**  
**DE Bewegungsrichtung**  
**RU Движение**





**EN Location / Position Arrow**  
**DE Anordnung/Position**  
**RU Расположение**

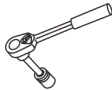

**EN Screw Arrow**  
**DE Drehrichtung**  
**RU Поворот**

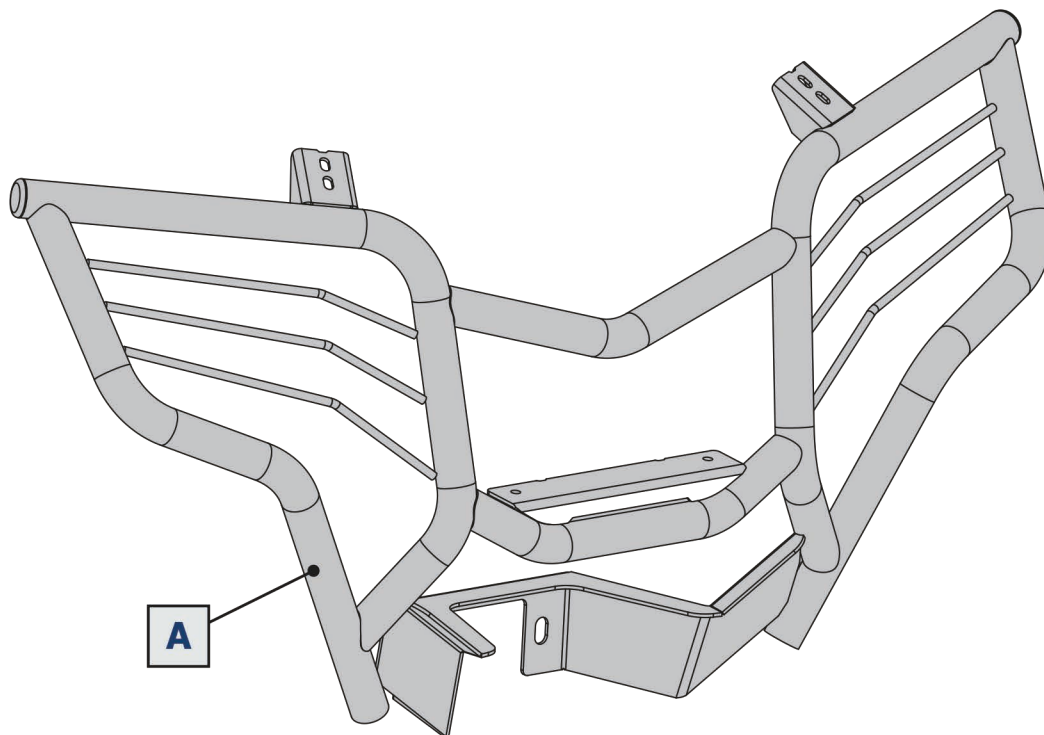
 <p>EN Ratchet DE Ratsche RU Трещётка</p>	 <p>HEX S - 5</p>
--	--

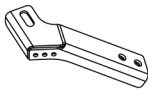
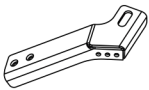
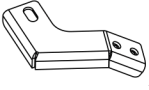
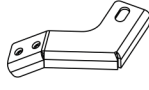

<p><b>1</b></p>  <p>x1</p>	<p><b>2</b></p>  <p>x1</p>	<p><b>3</b></p>  <p>x1</p>	<p><b>4</b></p>  <p>x1</p>	<p><b>5</b></p>  <p>M6x20 x4</p>	<p><b>6</b></p>  <p>ø6 x4</p>
---	---	---	---	---	--

