

EN SKID PLATE INSTALLATION MANUAL

DE MONTAGEEINLEITUNG FÜR UNTERBODENSCHUTZSYSTEM

RU ИНСТРУКЦИЯ ПО УСТАНОВКЕ ЗАЩИТЫ



**For: OSM SM1000 (2023-)**

444.8520.1



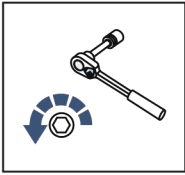

EN Regular fasteners  
DE Schraube herausdrehen  
RU Штатный крепеж

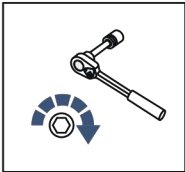

EN Regular fasteners  
DE Schraube eindrehen und festziehen  
RU Штатный крепеж

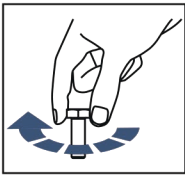

EN Screw a several turns  
DE Schraube wenige Umdrehungen eindrehen  
RU Вкрутить на несколько оборотов

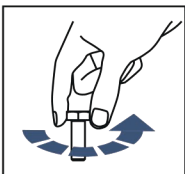

EN Loosen bolts  
DE Schraube wenige Umdrehungen lösen  
RU Выкрутить на несколько оборотов

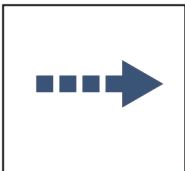

EN Movement Arrow  
DE Bewegungsrichtung  
RU Движение

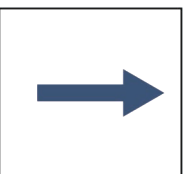

EN Location/Position Arrow  
DE Blickrichtung / Postionsrichtung  
RU Расположение



EN Screw Arrow  
DE Drehrichtung  
RU Поворот



S - 10;  
S - 13



S - 4







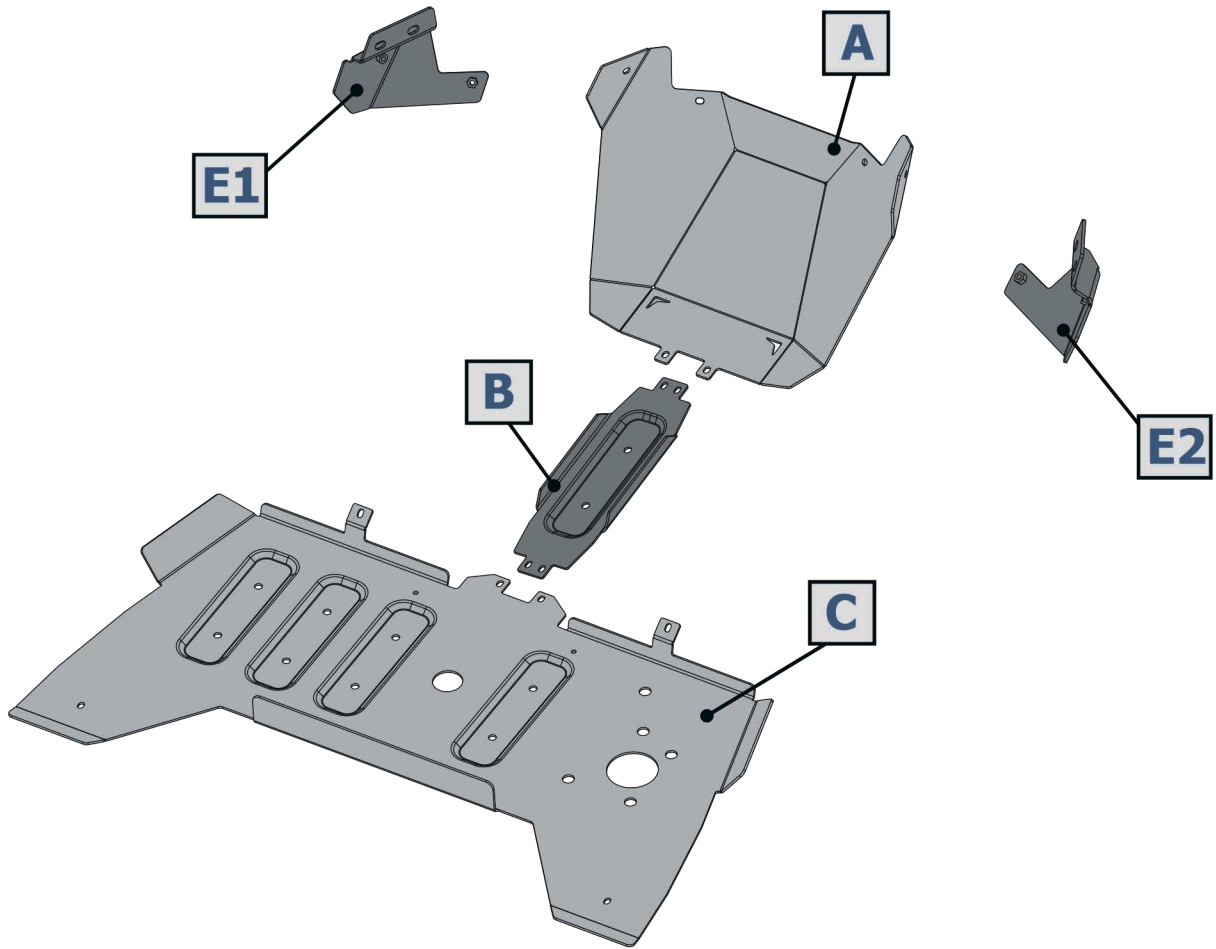

EN Office Knife  
DE Büromesser  
RU Канцелярский нож

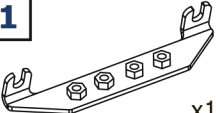
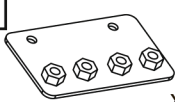

EN Hand Riveter  
DE Handnietzange  
RU Ручной заклёпочник



<b>1</b>  x1	<b>2</b>  x1	<b>3</b>  M6x16 x14	<b>4</b>  M6x20 x2	<b>5</b>  4,8x20 x2	<b>6</b>  Ø6 x16
<b>7</b>  Ø8 x4					

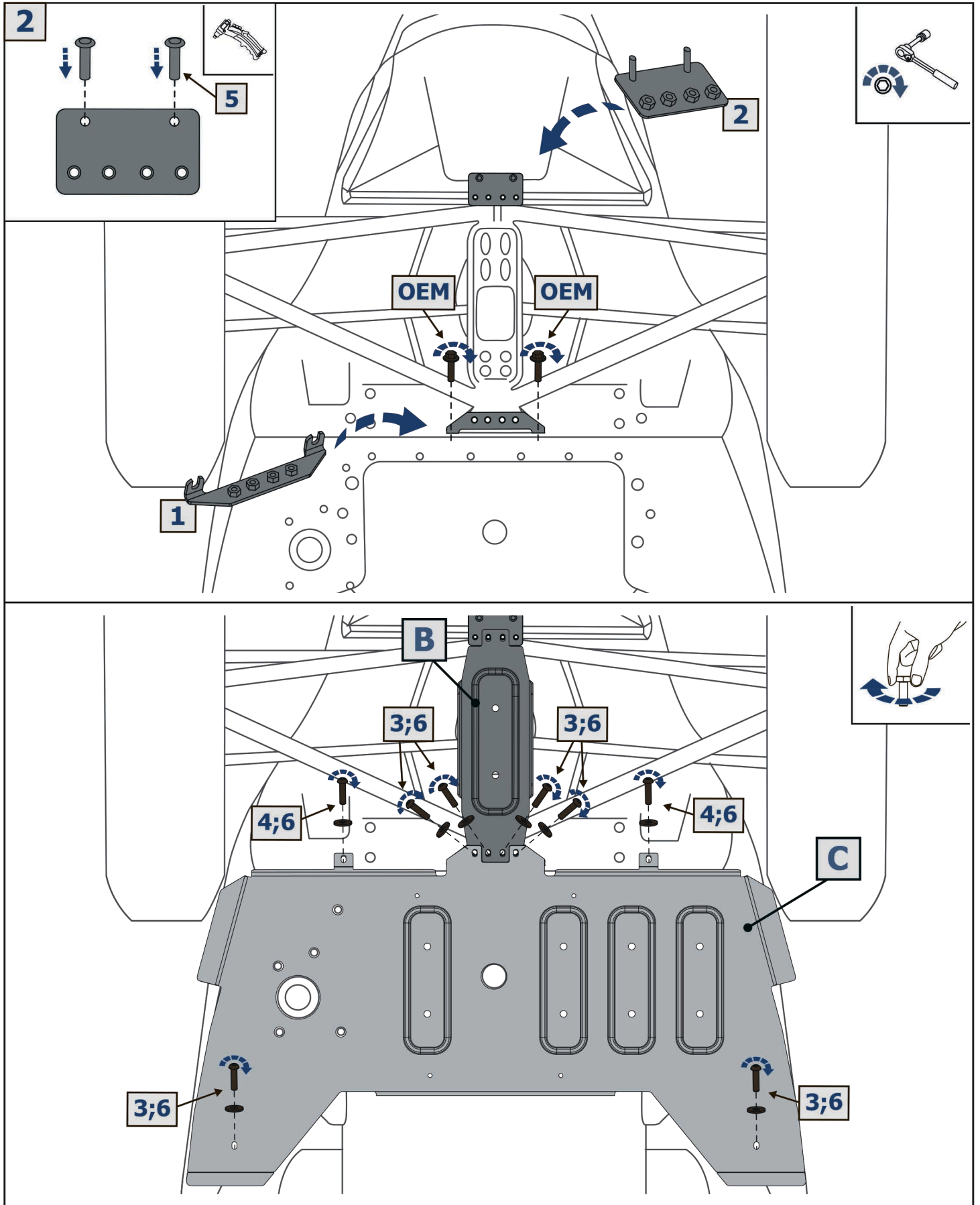

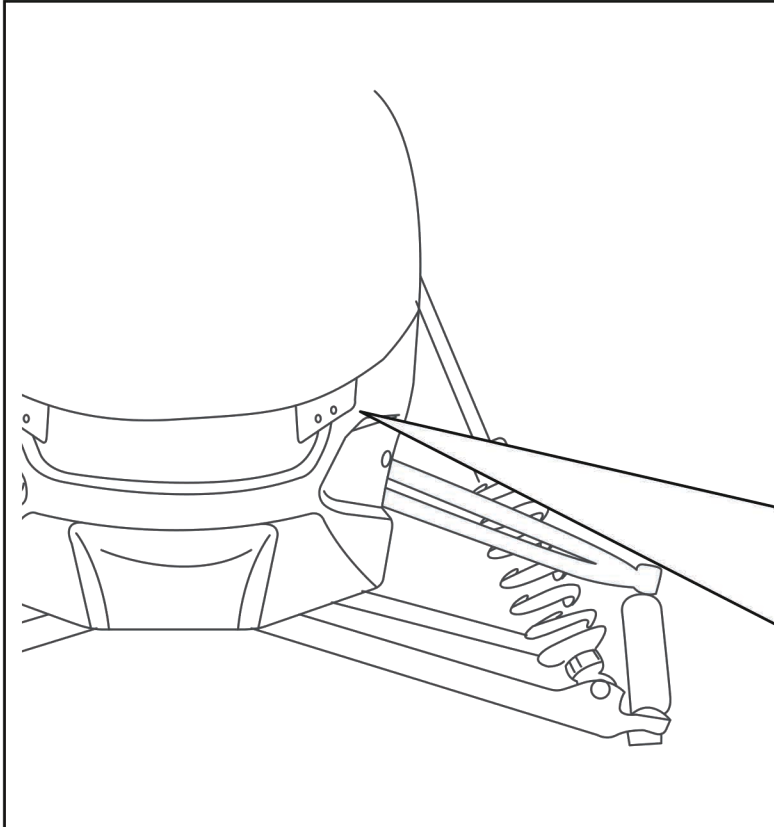

LEFT = RIGHT

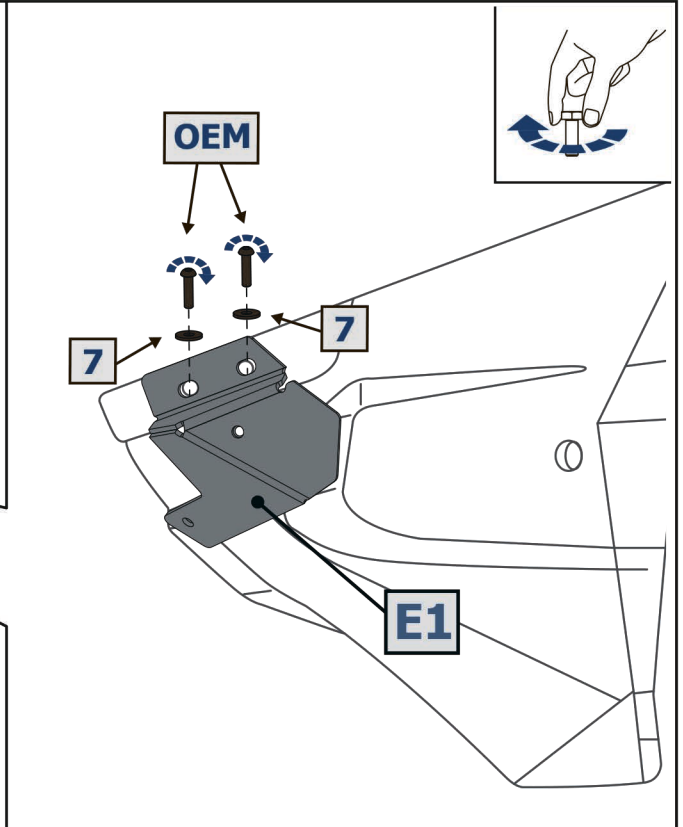

E1=E2

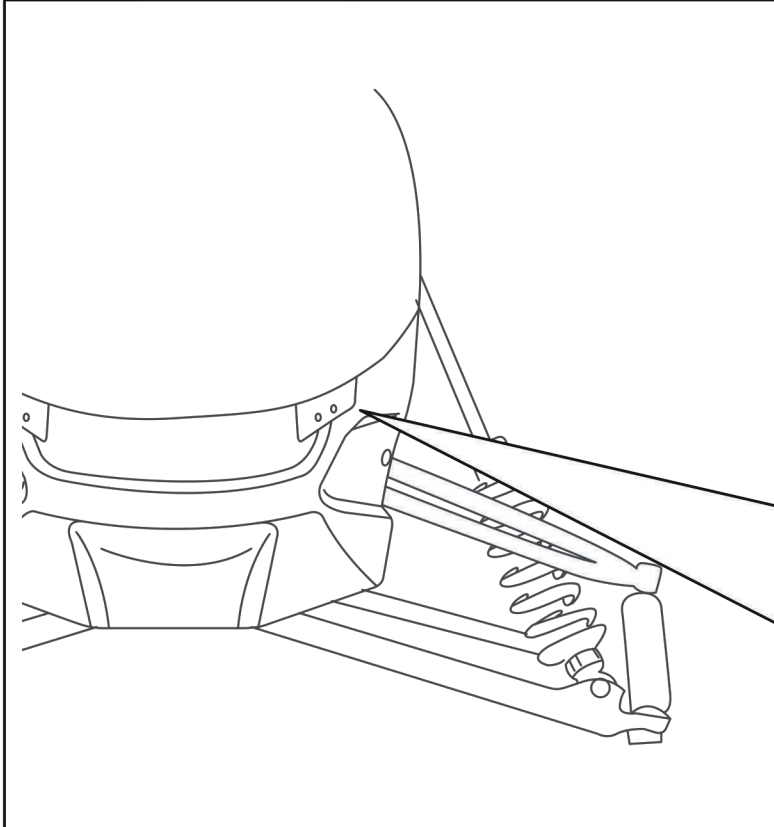

LEFT = RIGHT

