

EN	SKID PLATE INSTALLATION MANUAL
FR	MANUEL D'INSTALLATION DE PLAQUE DE PROTECTION
DE	MONTAGEEINLEITUNG FÜR UNTERBODENSCHUTZSYSTEM
RU	ИНСТРУКЦИЯ ПО УСТАНОВКЕ КОМПЛЕКТА ЗАЩИТ



**For: Kymco UXV 450i (2015- )**

444.7503.1  
2444.7503.1



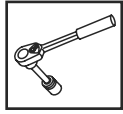

EN Ratchet  
FR Clé À Cliquet  
DE Ratsche  
RU Трещетка

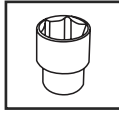



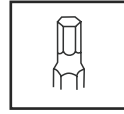



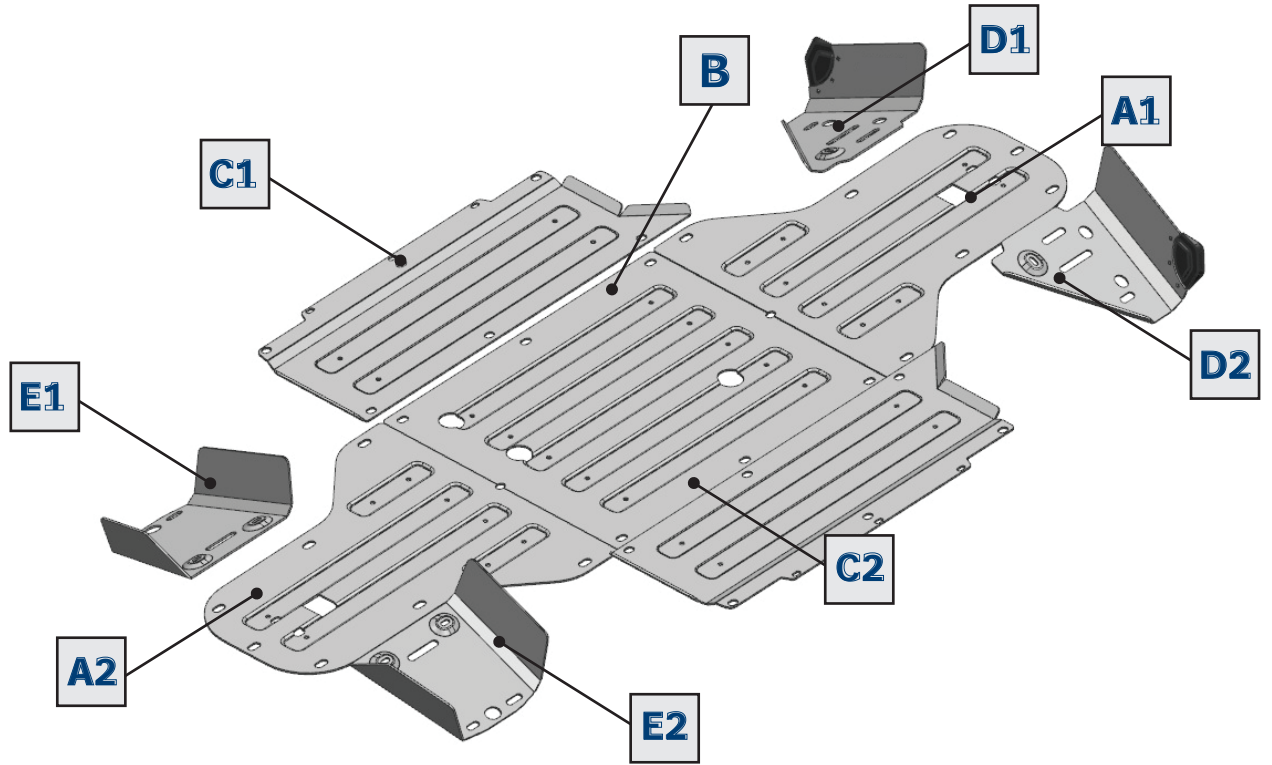

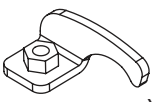
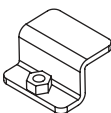

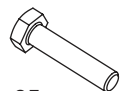
S - 10;  
S - 13

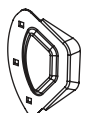

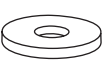
S - 4;  
S - 5



1	 x6	2	 x2	3	 M6x20 x4	4	 M8x25 x8	5	 M6x16 x6	6	 x2
7	 Ø6 x6	8	 Ø6 x6	9	 Ø8 x6	10	 Ø6 x4	11	 Ø8 x2	12	 M6 x6

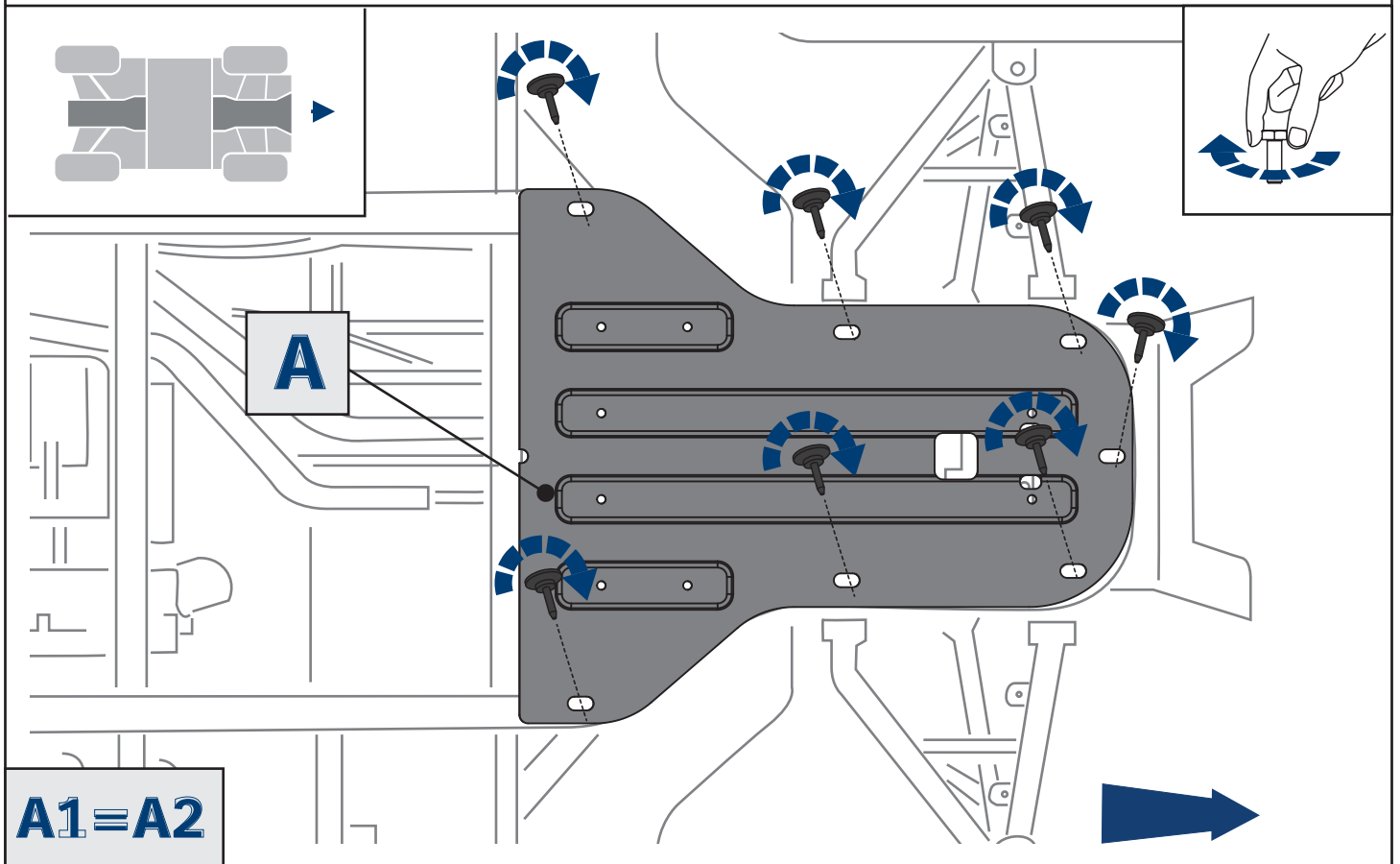
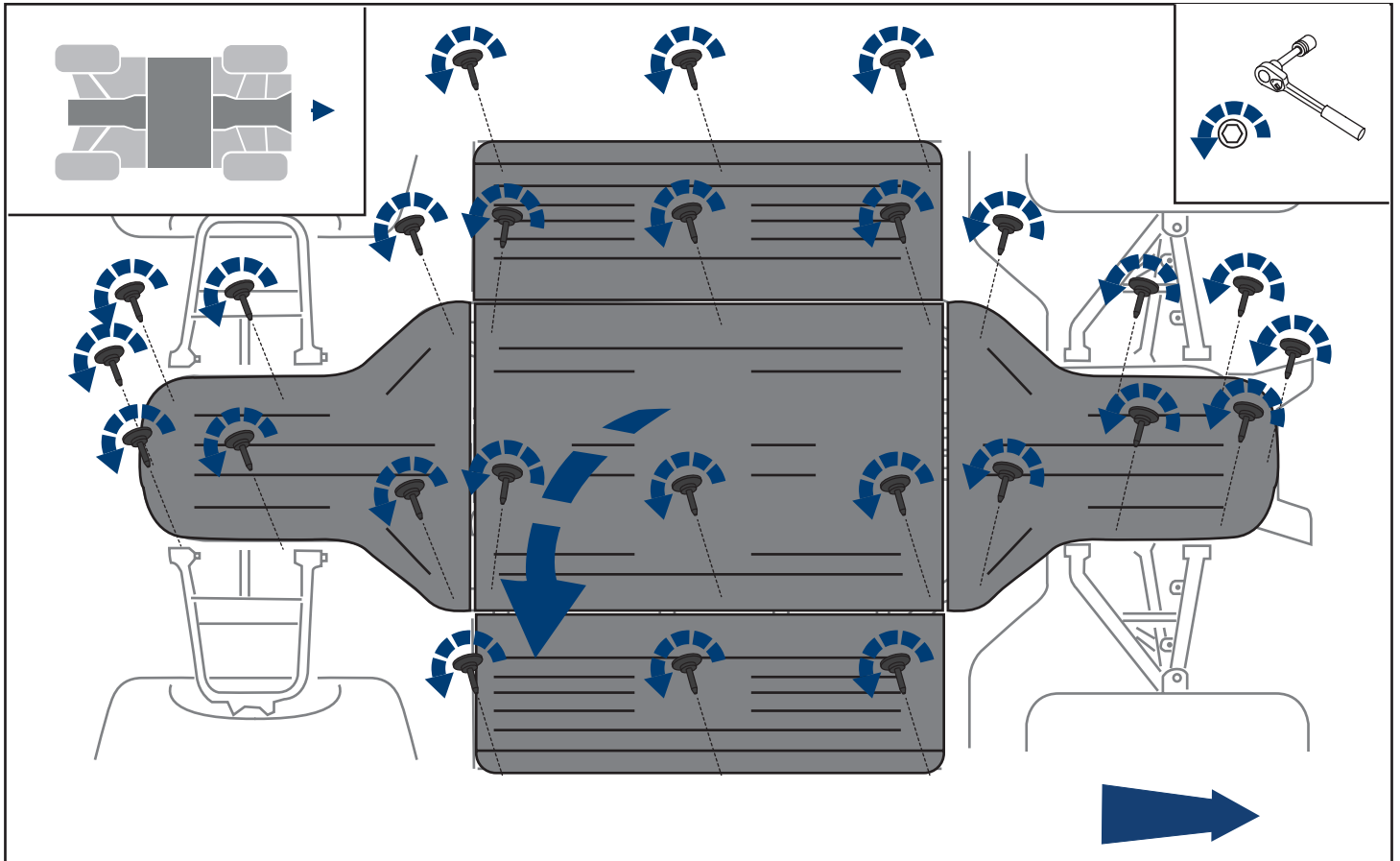

**A1=A2**

