

**EN** SKID PLATE INSTALLATION MANUAL

**FR** MANUEL D'INSTALLATION DE PLAQUE DE PROTECTION

**DE** MONTAGEEINLEITUNG FÜR UNTERBODENSCHUTZSYSTEM



**For:** Polaris Ranger XP 900 (2011-)  
Polaris Ranger XP 1000 (2016-)  
2444.7430.1  
444.7430.1



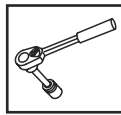

EN Ratchet  
FR Clé À Cliquet  
DE Ratsche

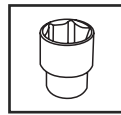



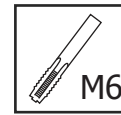

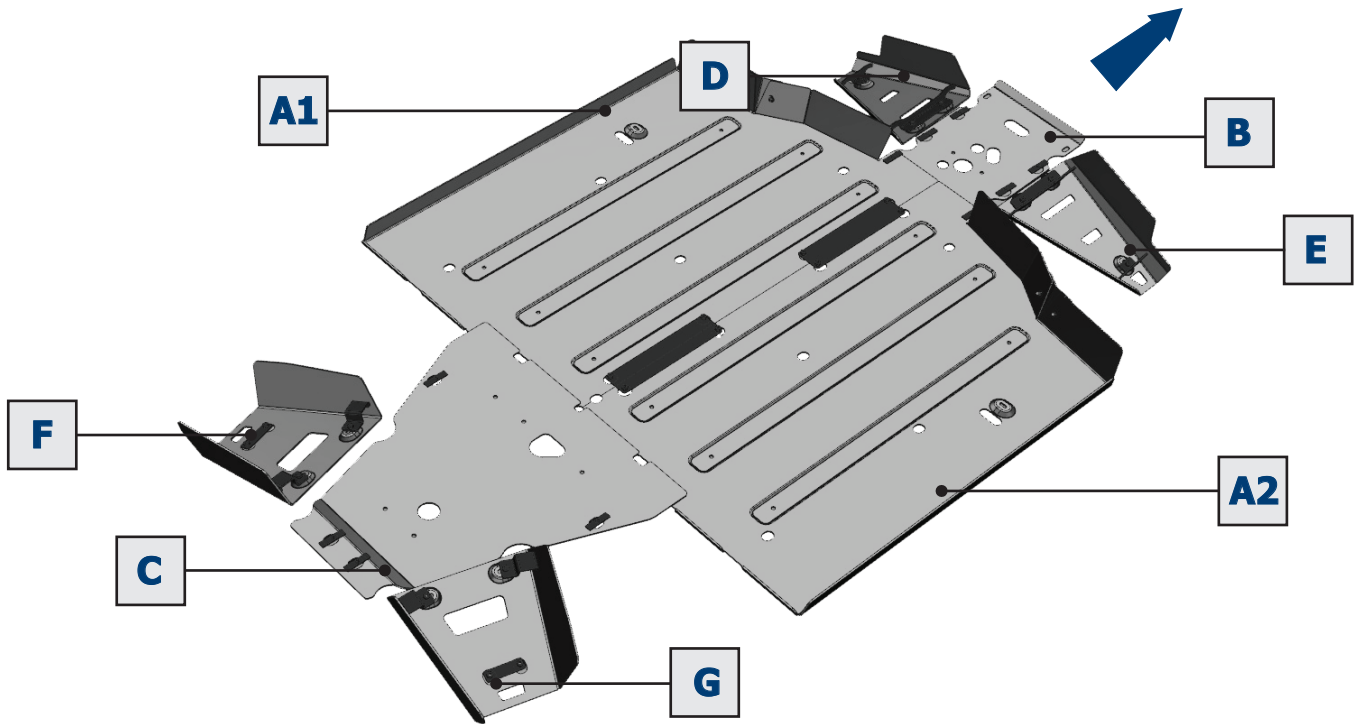

S - 10;  
S - 13

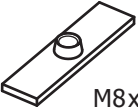
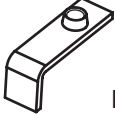
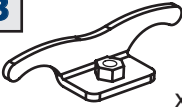
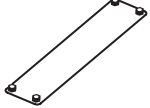
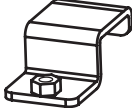
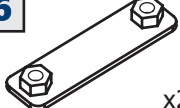
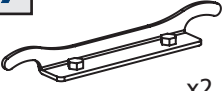

M6



|          |                                                                                              |          |                                                                                              |          |                                                                                              |           |                                                                                            |           |                                                                                             |           |                                                                                             |
|----------|----------------------------------------------------------------------------------------------|----------|----------------------------------------------------------------------------------------------|----------|----------------------------------------------------------------------------------------------|-----------|--------------------------------------------------------------------------------------------|-----------|---------------------------------------------------------------------------------------------|-----------|---------------------------------------------------------------------------------------------|
| <b>1</b> | <br>M8x10 | <b>2</b> | <br>M8x2  | <b>3</b> | <br>x2    | <b>4</b>  | <br>x2 | <b>5</b>  | <br>x4 | <b>6</b>  | <br>x2 |
| <b>7</b> | <br>x2     | <b>8</b> | <br>M6x25 | <b>9</b> | <br>M8x25 | <b>10</b> | <br>ø8 | <b>11</b> | <br>ø6 | <b>12</b> | <br>ø8 |
|          |                                                                                              |          |                                                                                              |          |                                                                                              |           |                                                                                            |           |                                                                                             |           |                                                                                             |
|          |                                                                                              |          |                                                                                              |          |                                                                                              |           |                                                                                            |           |                                                                                             |           |                                                                                             |
|          |                                                                                              |          |                                                                                              |          |                                                                                              |           |                                                                                            |           |                                                                                             |           |                                                                                             |

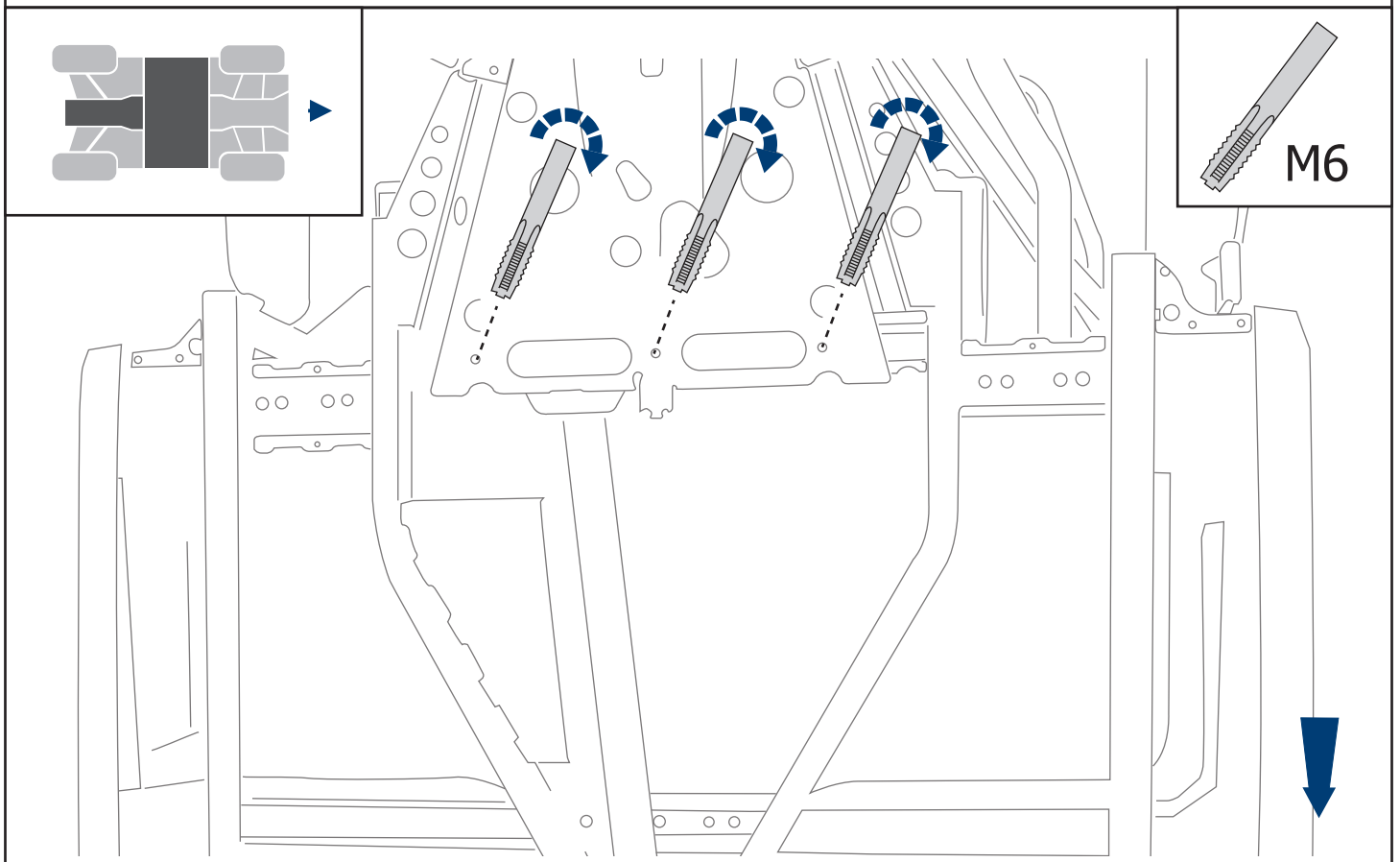
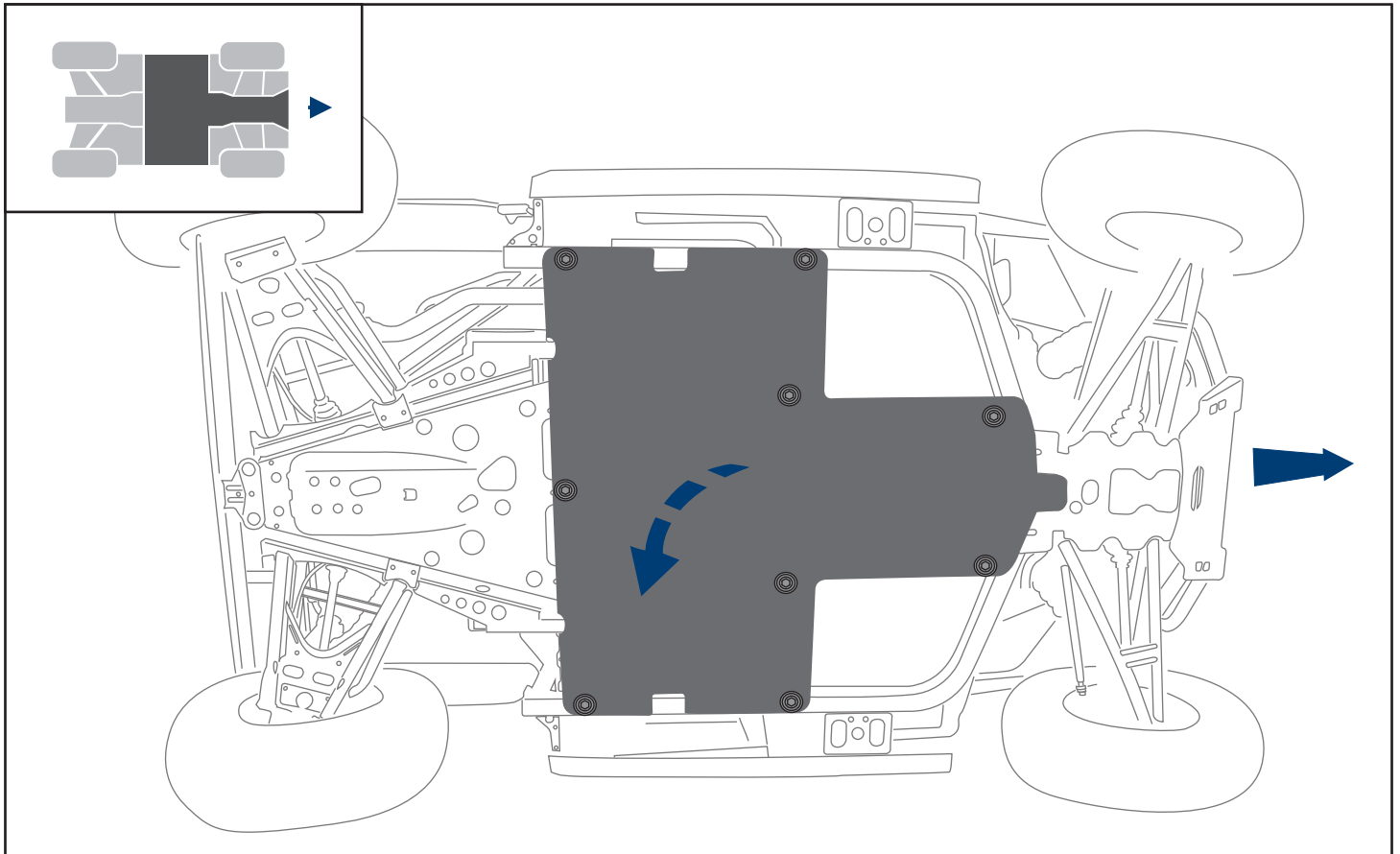

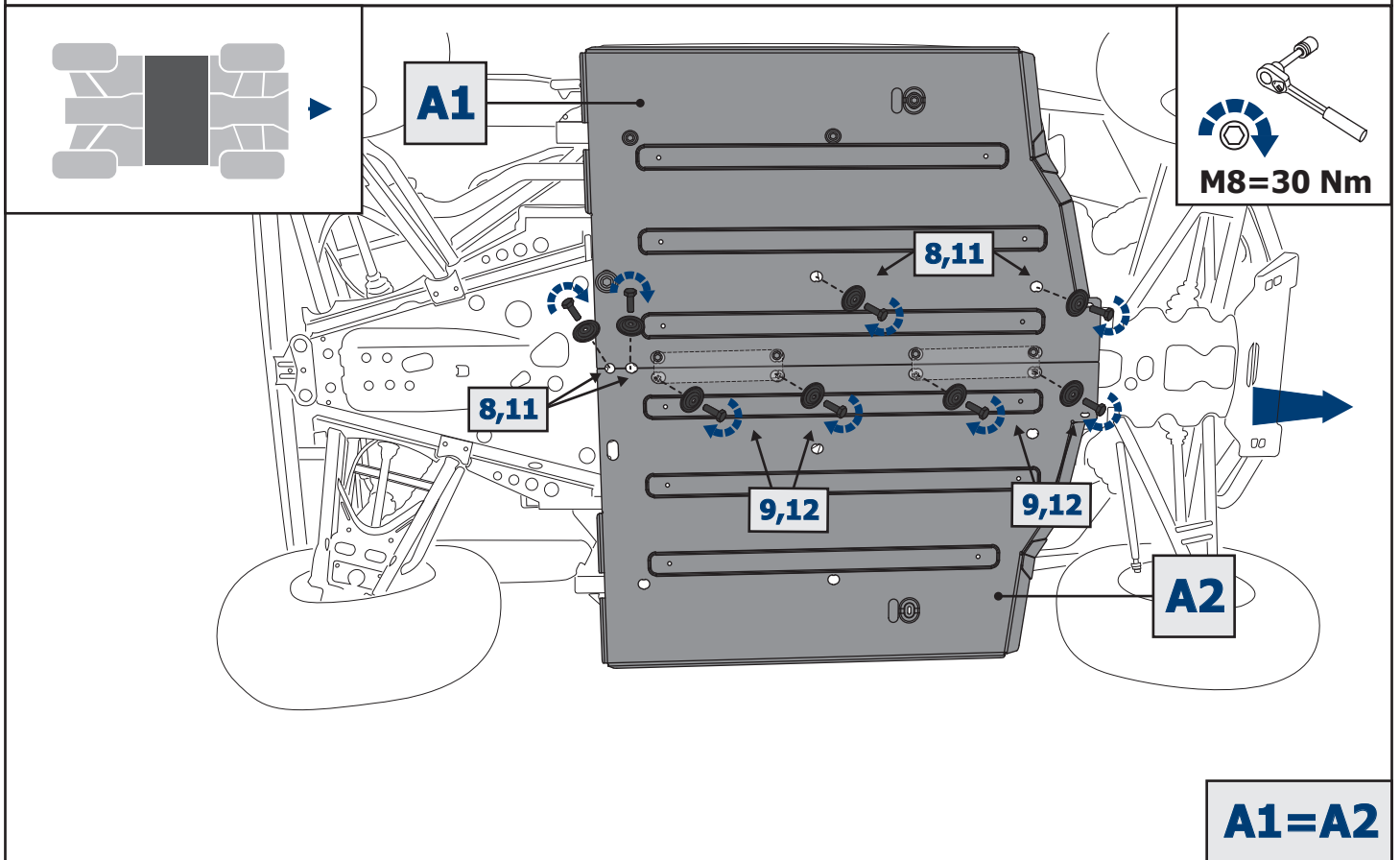
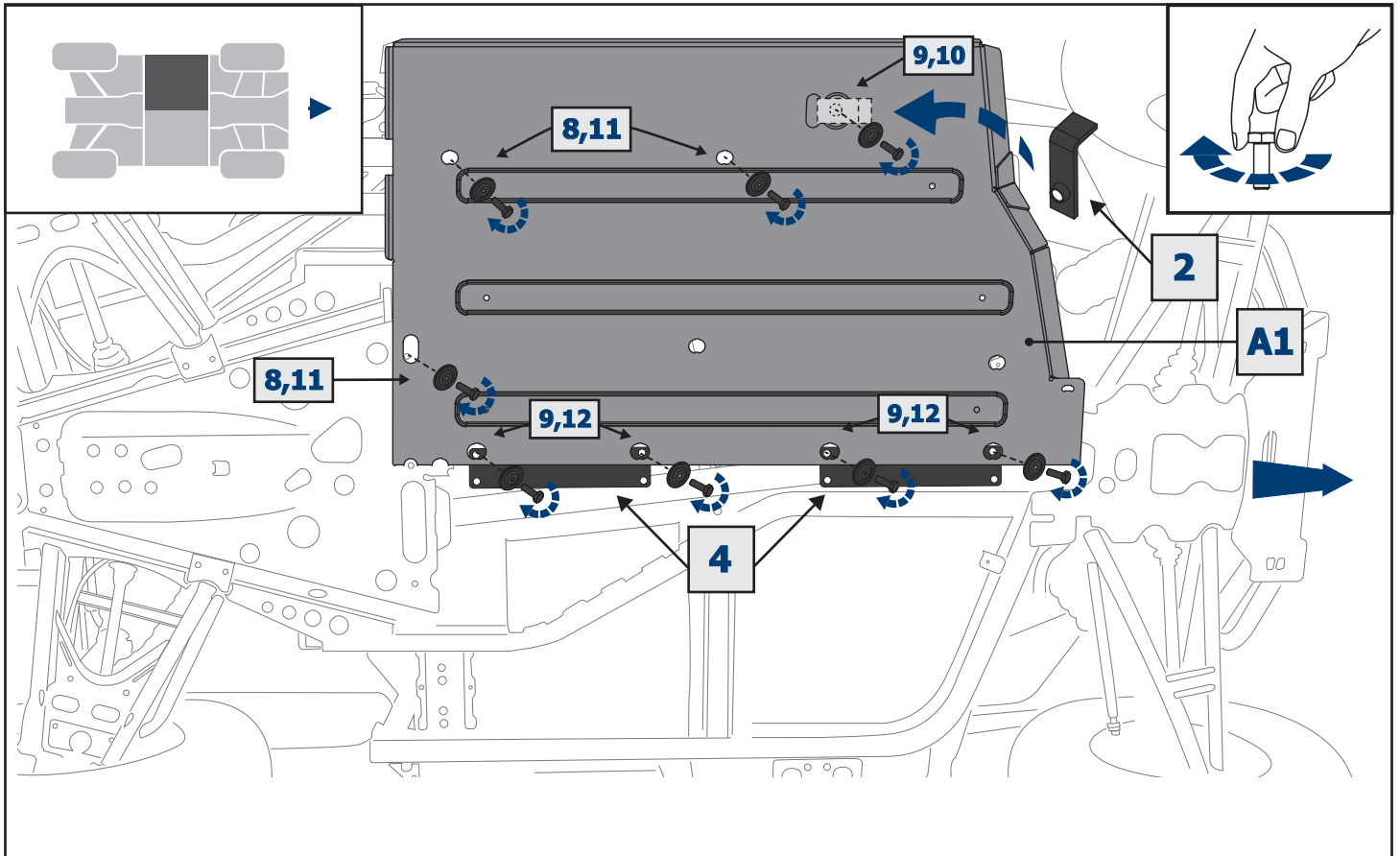

**A1=A2**

