

EN SKID PLATE INSTALLATION MANUAL

DE MONTAGEANLEITUNG FÜR UNTERBODENSCHUTZ SYSTEM

RU ИНСТРУКЦИЯ ПО УСТАНОВКЕ КОМПЛЕКТА ЗАЩИТ



For: STELS STAVR (2021-)

444.6761.1

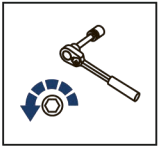

EN Regular fasteners
DE Originale montageteile
RU Штатный крепеж

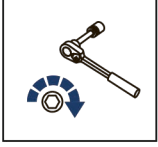

EN Regular fasteners
DE Originale montageteile
RU Штатный крепеж



EN Screw a several turns
DE Für wenigen Umdrehungen befestigen
RU Вкрутить на несколько оборотов



EN Loosen bolts
DE Bolzen lockern
RU Выкрутить на несколько оборотов

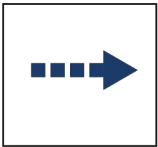

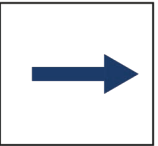

EN Movement Arrow
DE Bewegungsrichtung
RU Движение







EN Location/Position Arrow
DE Anordnung/Positionsrichtung
RU Расположение

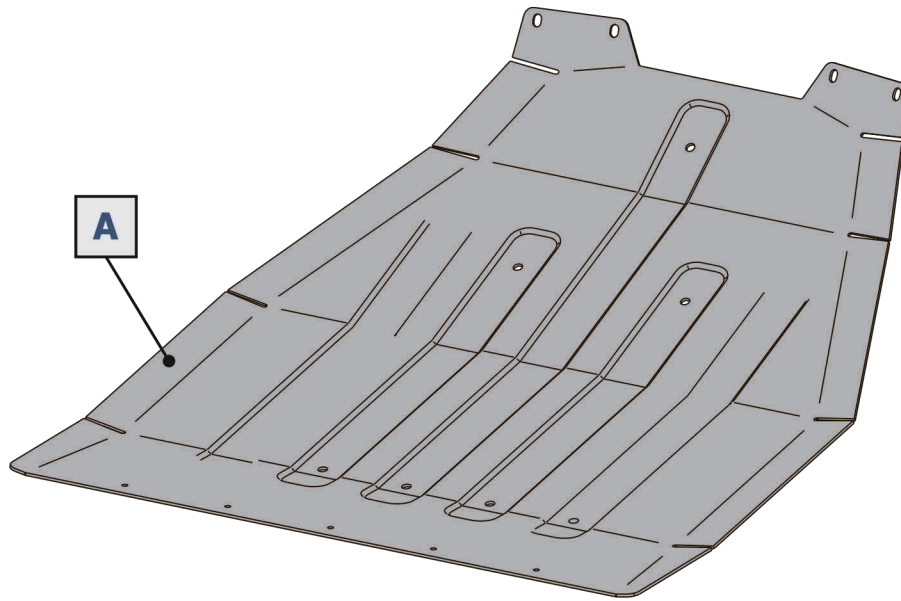

EN Screw Arrow
DE Drehungsrichtung
RU Поворот

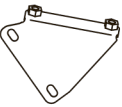
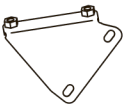
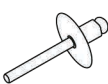
 EN Drill DE Bohrmaschine RU Дрель	 Ø 5	 EN Hand Riveter DE Handnietzange RU Ручной заклёпочник
---------------------------------------------------------------------------------------------------------------------------	---------------------------------------------------------------------------------------	------------------------------------------------------------------------------------------------------------------------------------------------



1  x1	2  x1	3  4.8x25 x5	4  M8x16 x4	5  Ø6 x4	6  Ø8 x4
7  Ø8 x4					

