

**EN SKID PLATE INSTALLATION MANUAL****DE MONTAGEEINLEITUNG FÜR UNTERBODENSCHUTZSYSTEM****For: Honda Pioneer 500 (2013- )**

2444.2112.1

444.2112.1

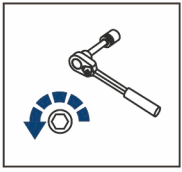



EN Regular fasteners  
DE Originale montageteile

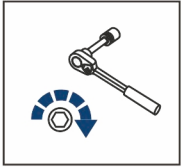

EN Regular fasteners  
DE Originale montageteile

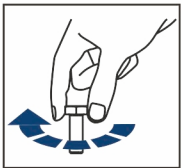

EN Screw a several turns  
DE Für wenigen Umdrehungen befestigen

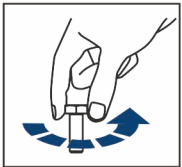

EN Loosen bolts  
DE Bolzen lockern

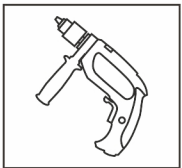

EN Drill  
DE Bohrer

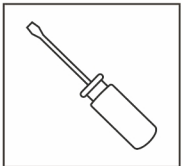

EN Screwdriver  
DE Schraubenzieher

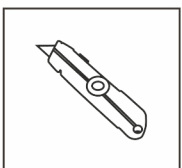

EN Office Knife  
DE Büromesser

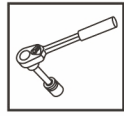



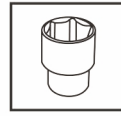

EN Ratchet  
DE Ratsche

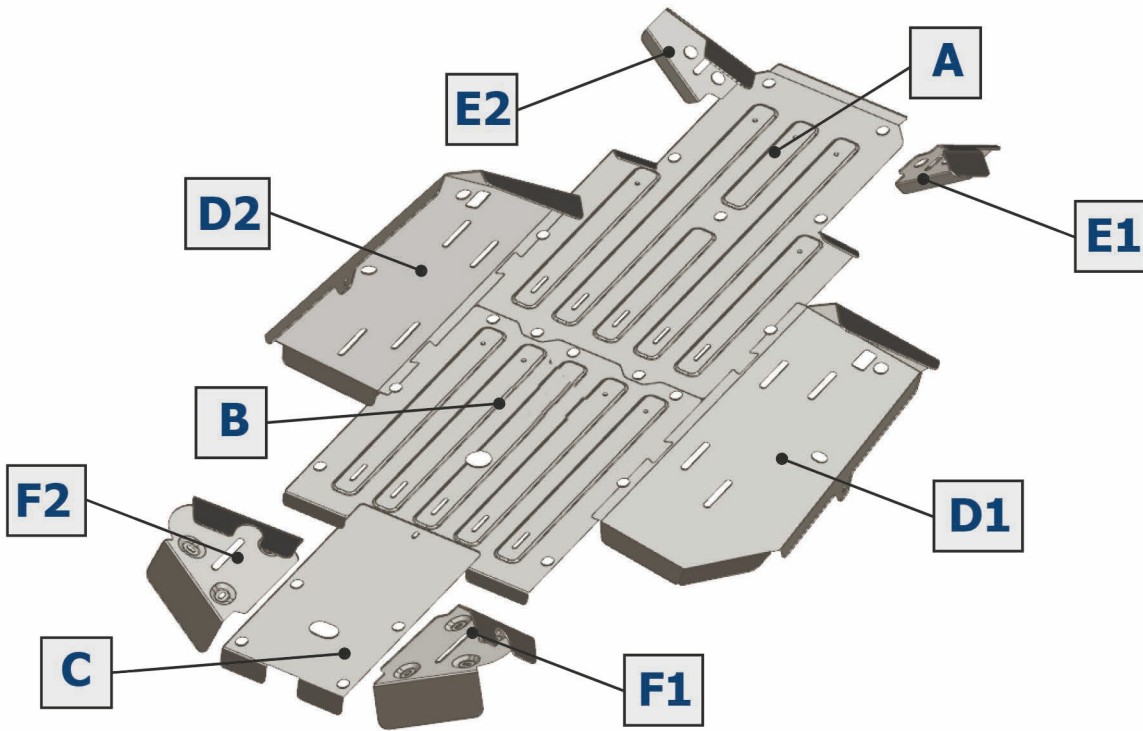

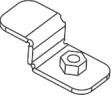
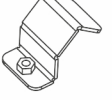
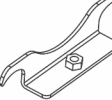
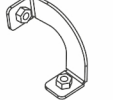
S - 10;  
S - 13

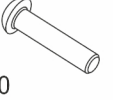
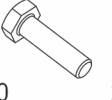
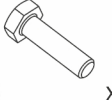
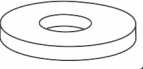

<b>1</b>	 x2	<b>2</b>	 x2	<b>3</b>	 x2	<b>4</b>	 x2	<b>5</b>	 x8	<b>6</b>	 M8x20 x2
<b>7</b>	 M6x20 x21	<b>8</b>	 M8x25 x16	<b>9</b>	 Ø8 x10	<b>10</b>	 Ø6 x21	<b>11</b>	 Ø8 x8		

