

EN FRONT BUMPER INSTALLATION MANUAL

DE MONTAGEEINLEITUNG FÜR STOBFÄNGER-KIT

RU ИНСТРУКЦИЯ ПО УСТАНОВКЕ ПЕРЕДНЕГО БАМПЕРА



For: AODES SNOWCROSS 1000 WT (2024-)

2444.8527.1

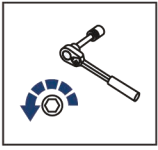

EN Regular fasteners
DE Normale Befestigung
RU Штатный крепёж

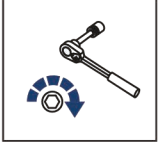

EN Regular fasteners
DE Normale Befestigung
RU Штатный крепёж



EN Screw a several turns
DE Mit wenigen Umdrehungen befestigen
RU Вкрутить на несколько оборотов



EN Loosen bolts
DE Bolzen lockern
RU Выкрутить на несколько оборотов

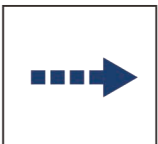

EN Movement Arrow
DE Bewegungsrichtung
RU Движение

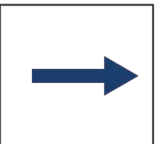

EN Location / Position Arrow
DE Anordnung / Positionsrichtung
RU Расположение



EN Screw Arrow
DE Drehrichtung
RU Поворот

	EN Ratchet DE Ratsche RU Трещётка		S - 10		HEX S - 5 S - 6		EN Drill DE Bohrmaschine RU Дрель		∅8 ∅11
--	---	--	--------	--	-----------------------	--	---	--	-----------

	EN Hand Riveter DE Handnietzange RU Ручной заклёпочник
--	--

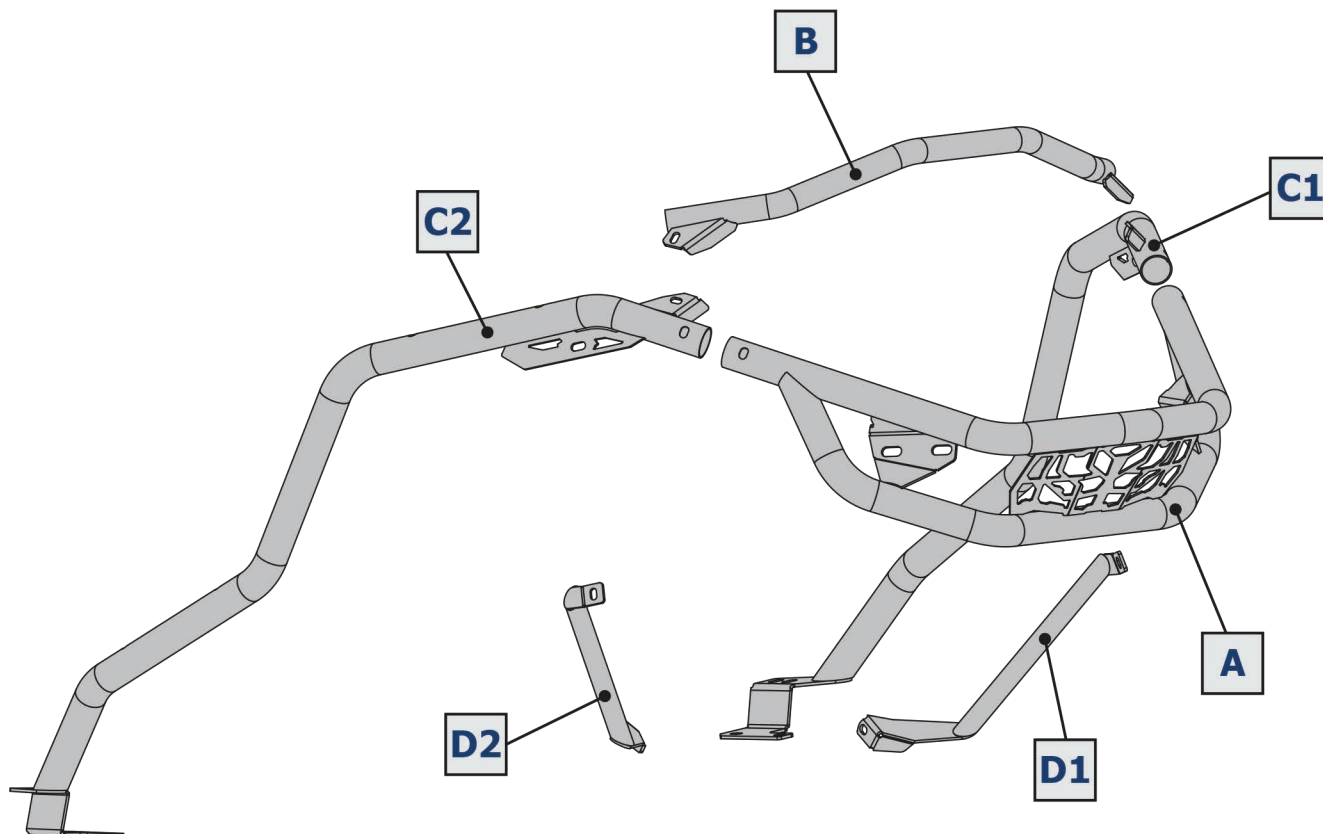

1 x1	2 x1	3 x1	4 x2	5 x2	6 x4
7 x4	8 x8	9 M8x20 x4	10 M6x20 x16	11 M6x45 x4	12 M6 x16
13 ∅8 x4	14 ∅6 x4	15 ∅6 x32			

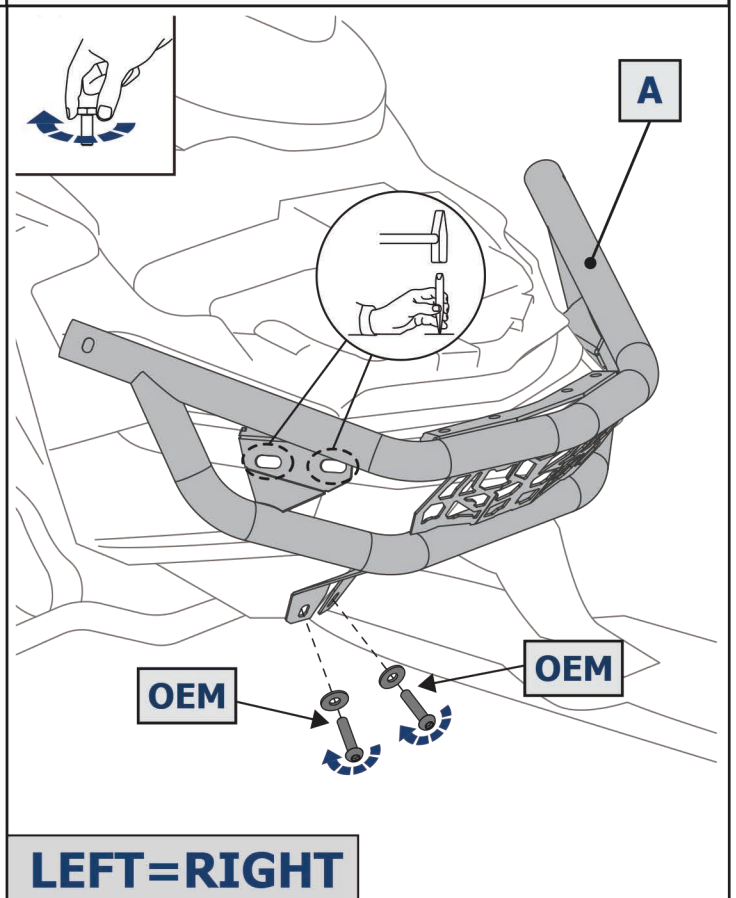
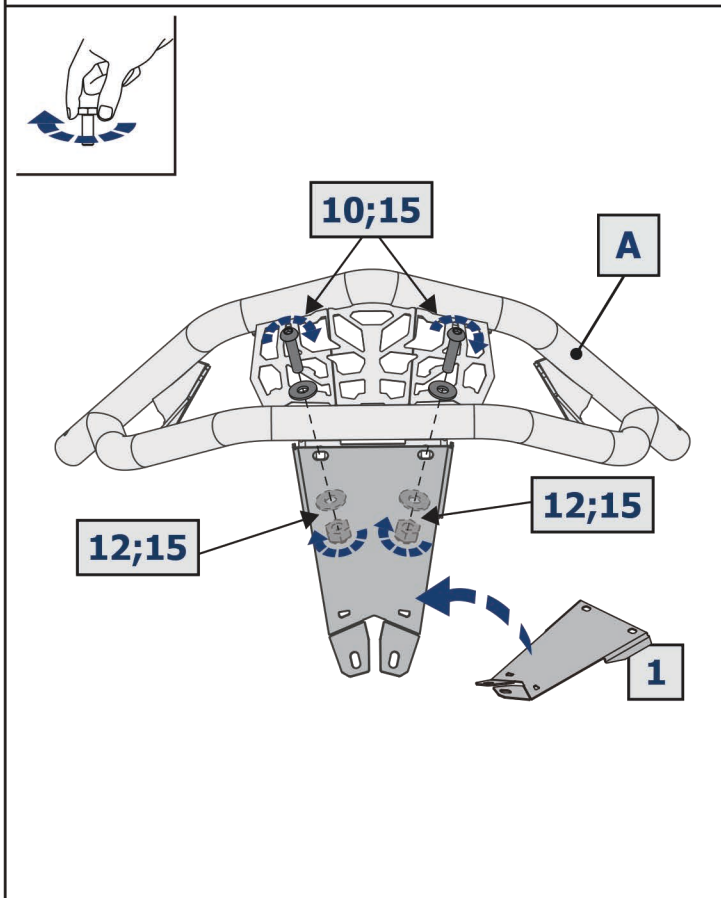
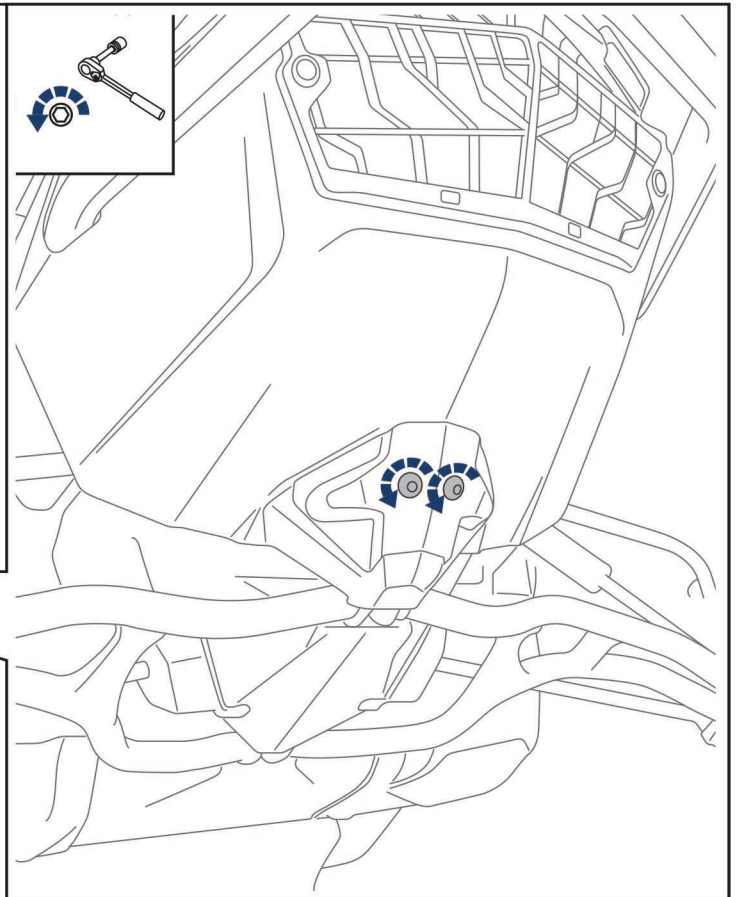

LEFT=RIGHT

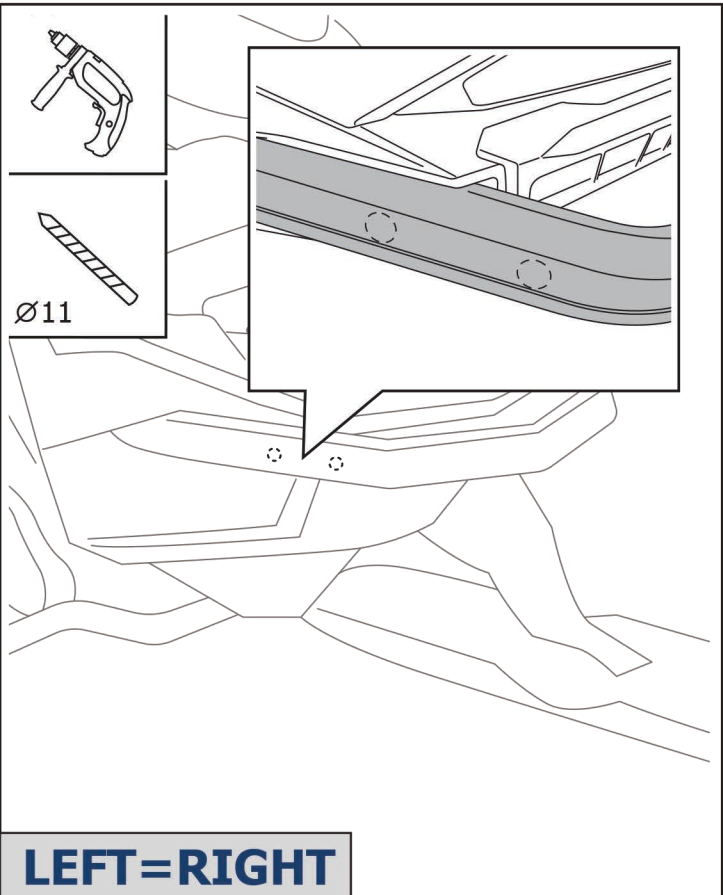
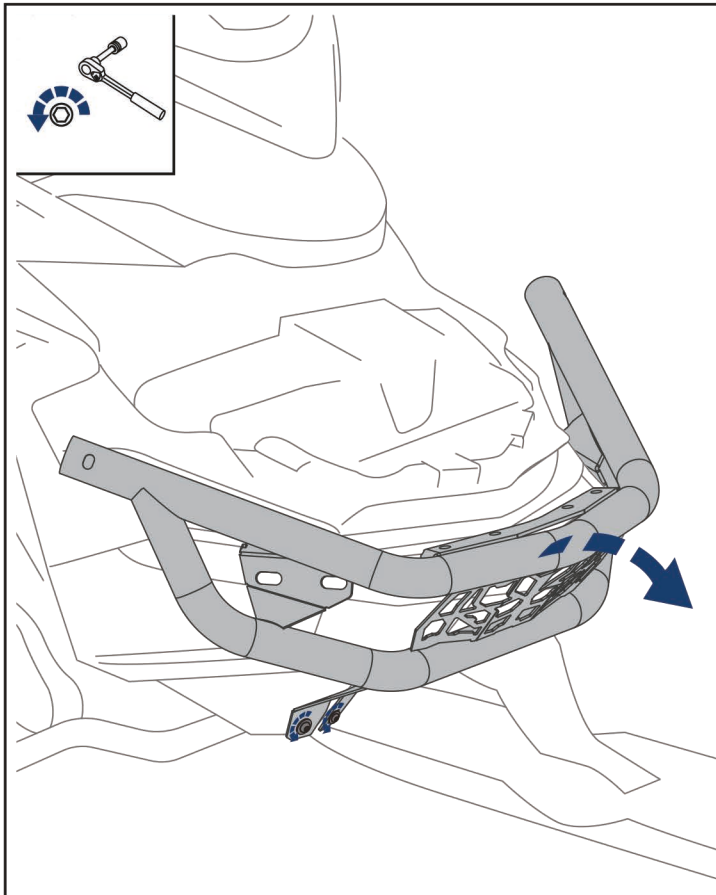

LEFT=RIGHT

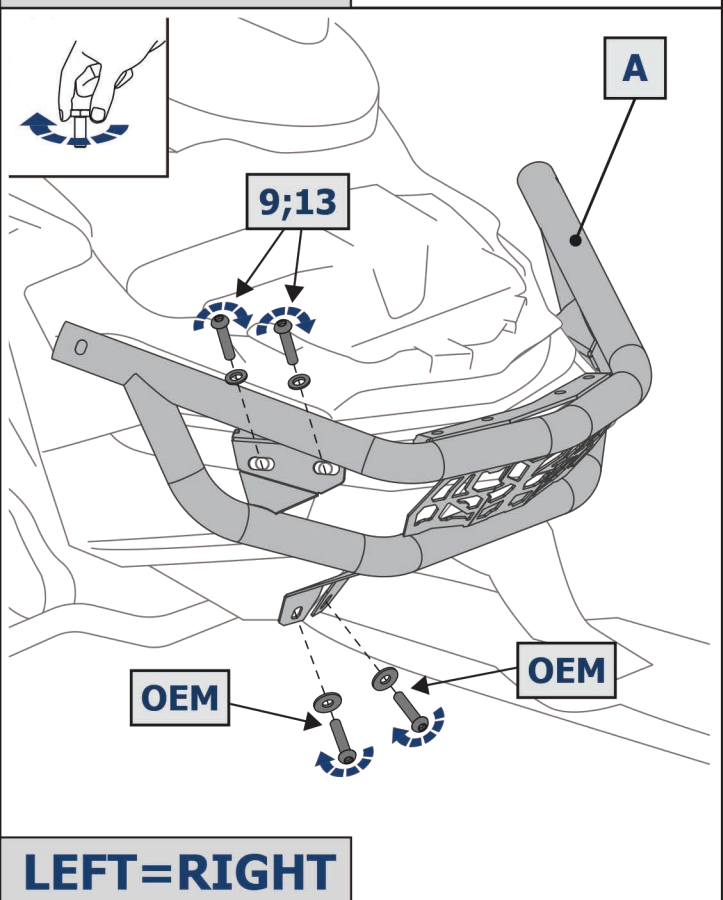
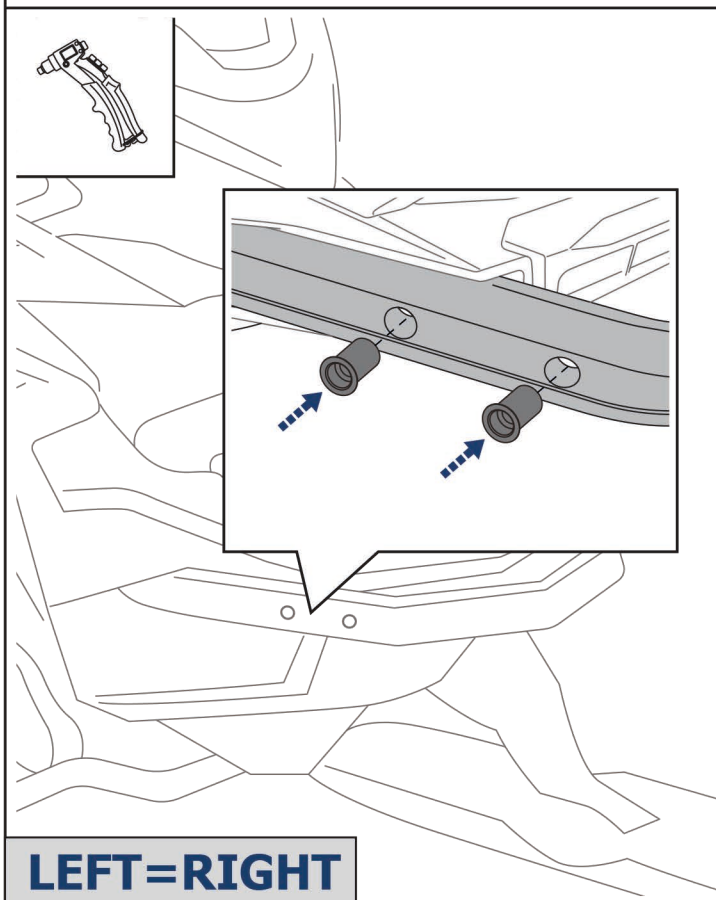

LEFT=RIGHT

LEFT=RIGHT

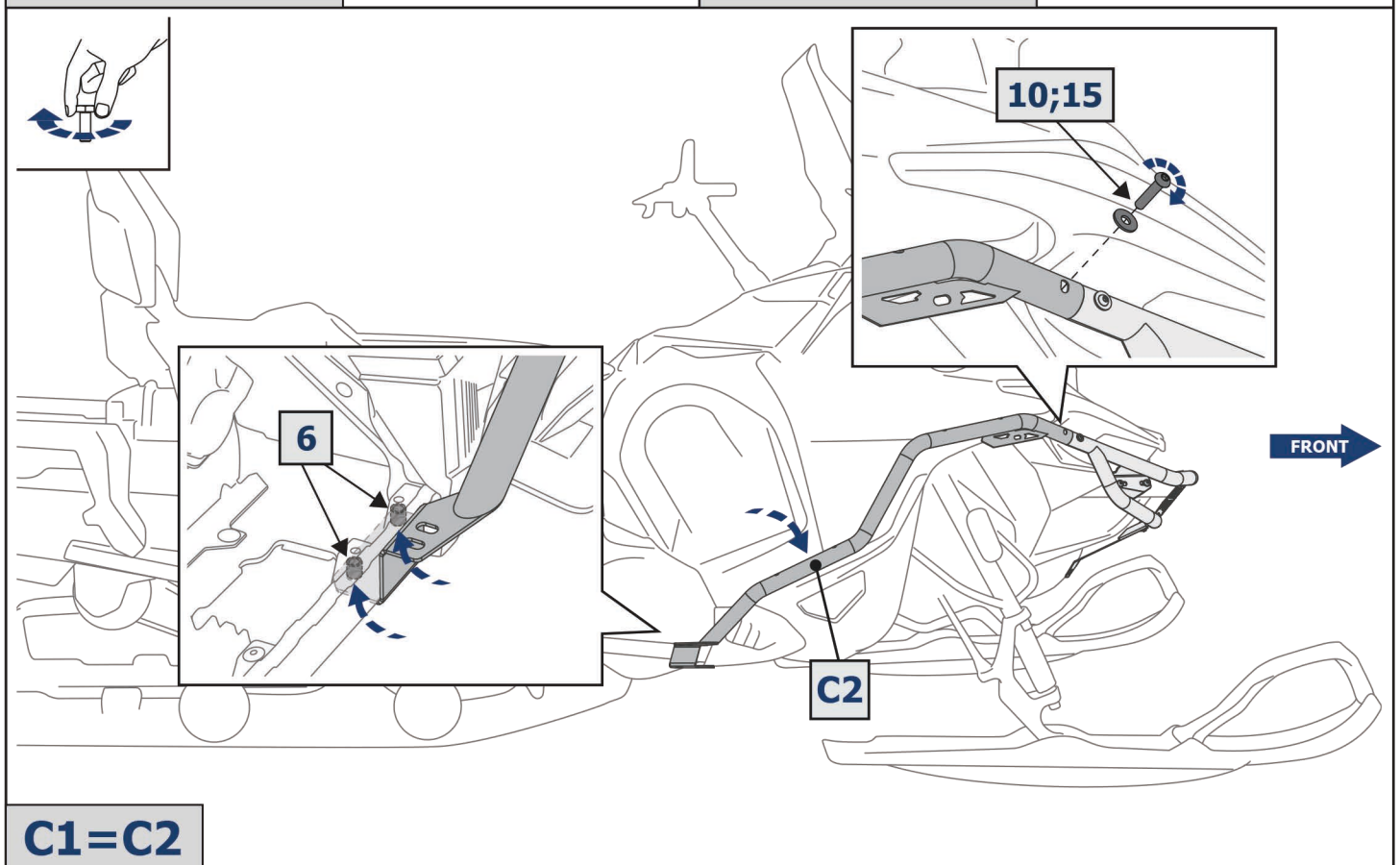
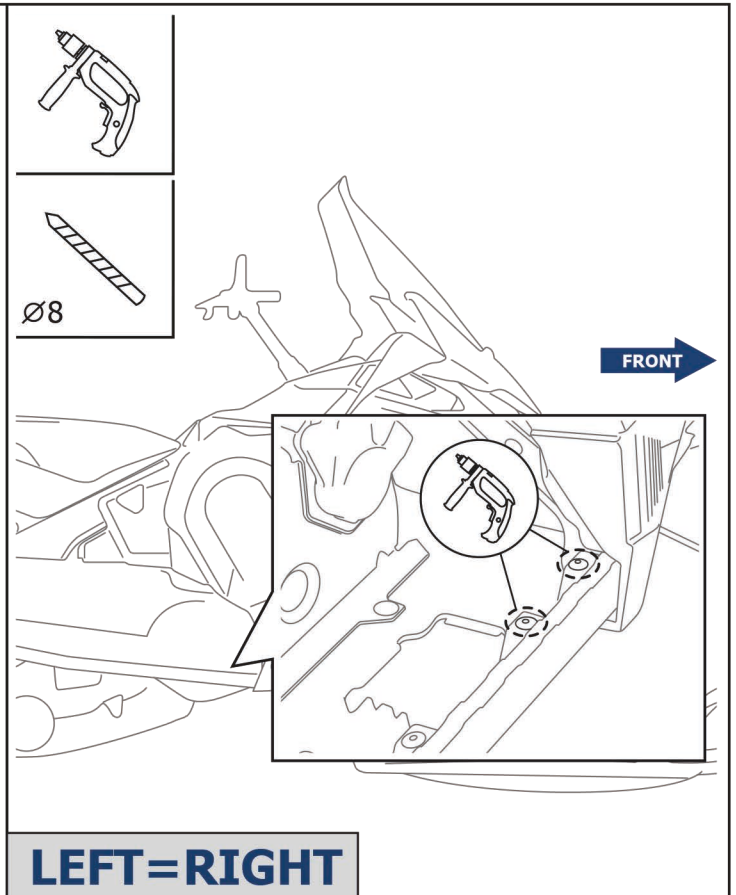
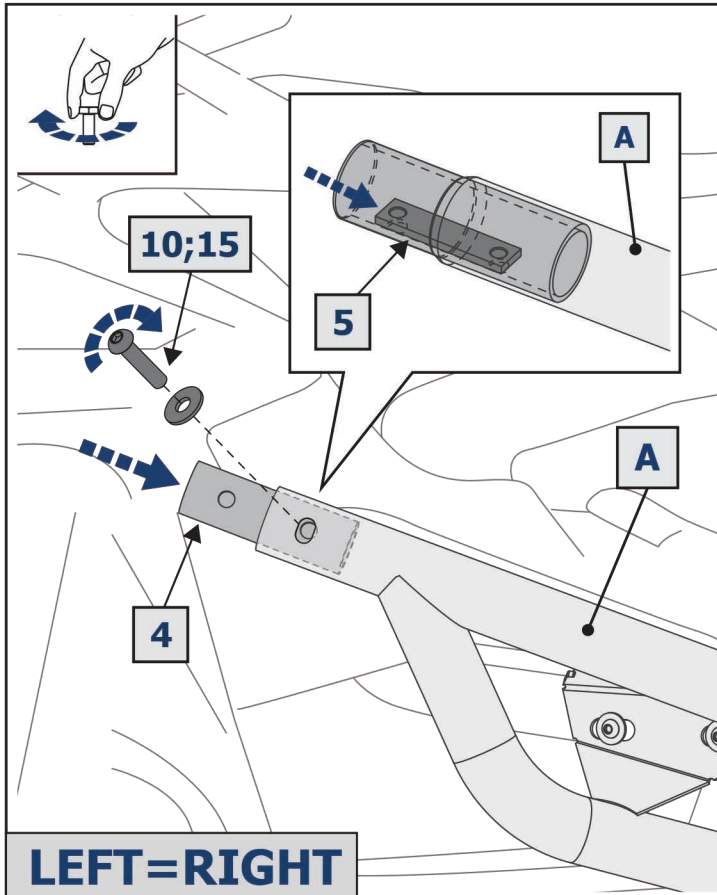

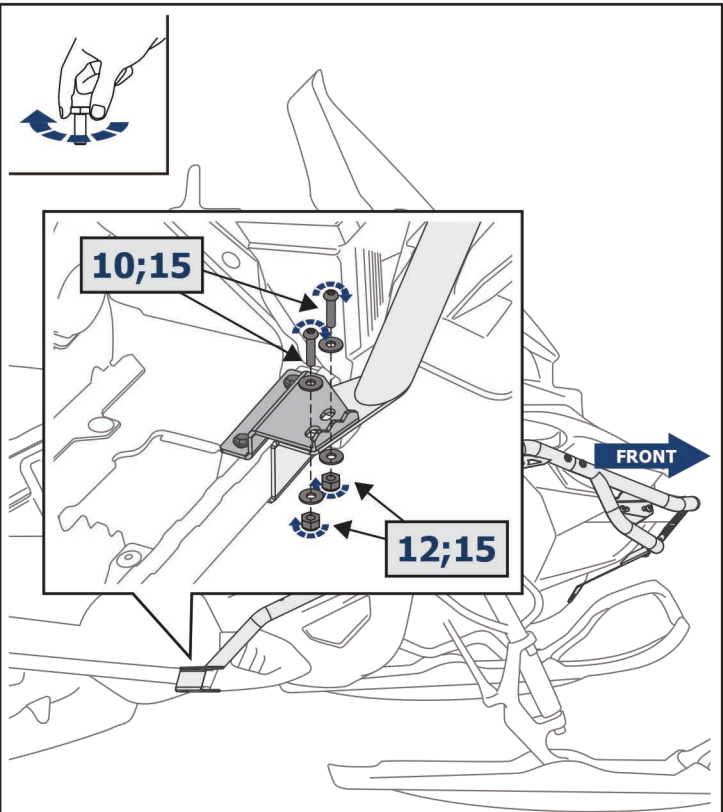
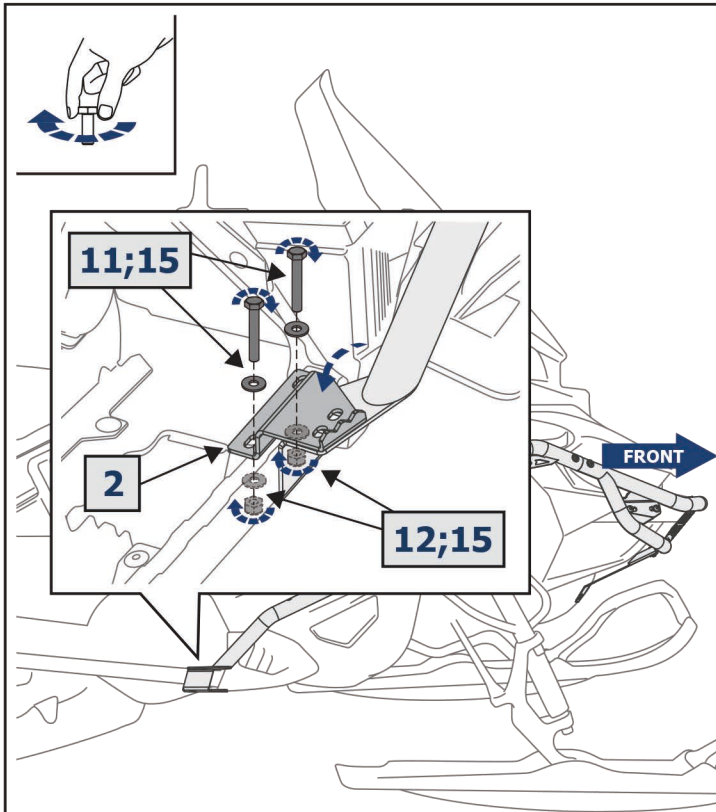

C1=C2

C1=C2

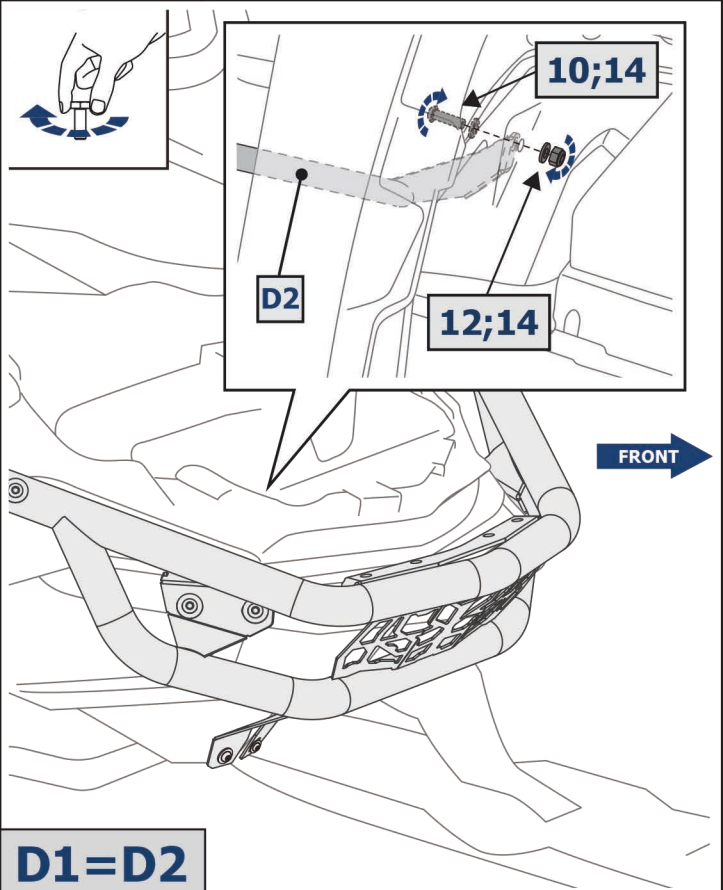
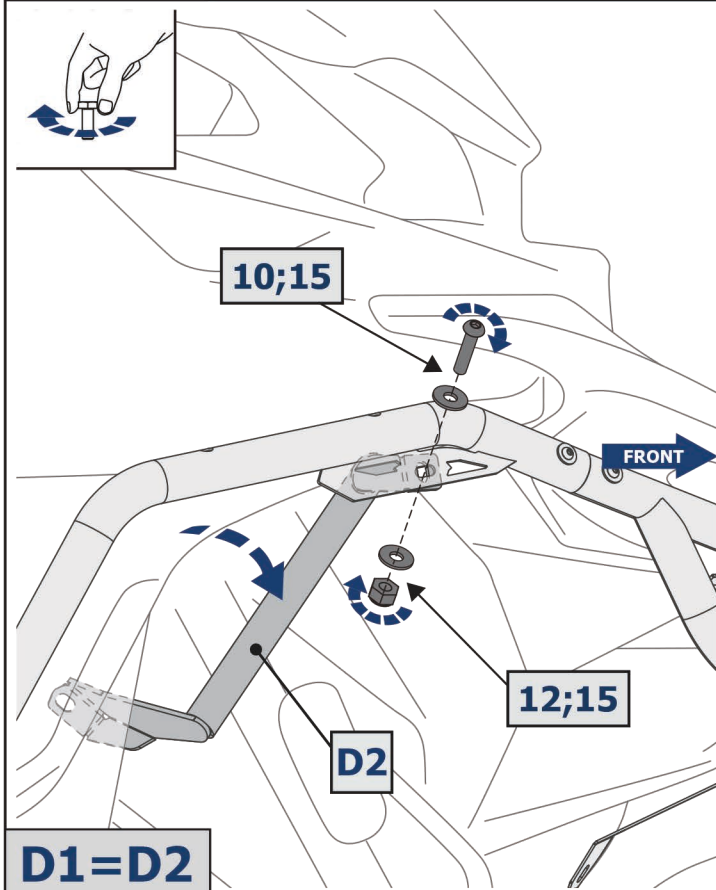

D1=D2

D1=D2

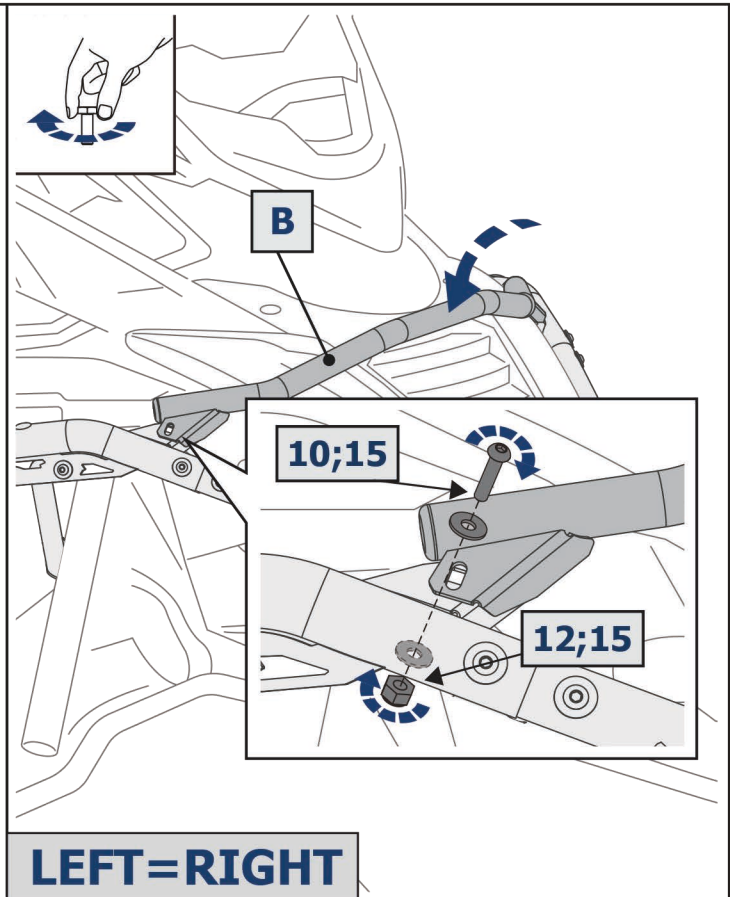
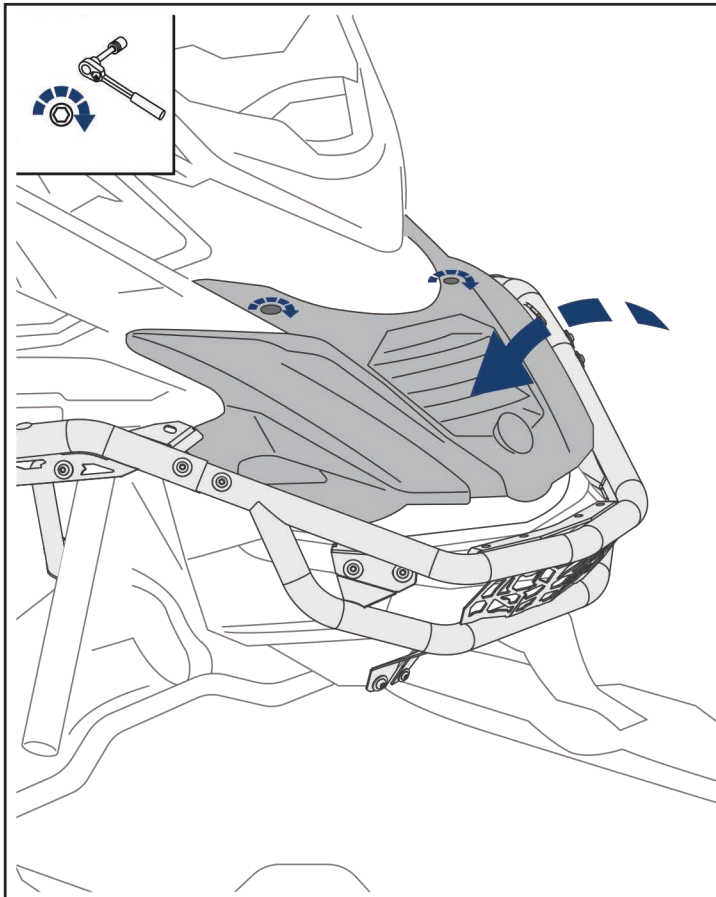

LEFT=RIGHT

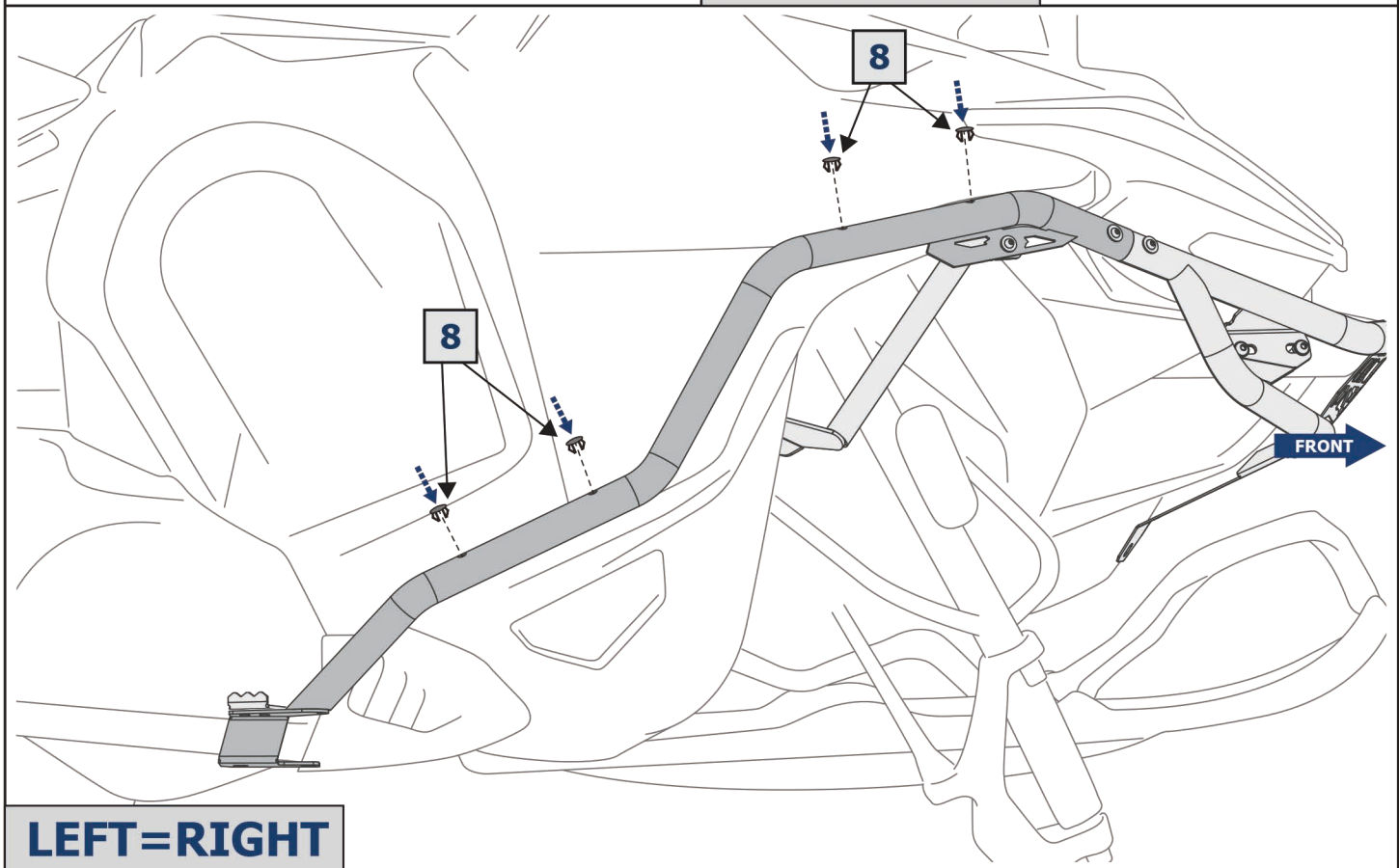

LEFT=RIGHT



M6=9.5 Nm



M8=24.0 Nm

