

EN	RADIATOR RELOCATION KIT WITH STAND INSTALLATION MANUAL
DE	HEIZKÖRPERVERLEGUNGSSATZ MIT STAND INSTALLATIONSANLEITUNG
RU	ИНСТРУКЦИЯ ПО УСТАНОВКЕ СТОЕК ДЛЯ ВЫНОСА РАДИАТОРА

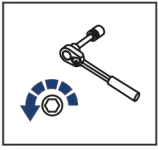

For: CFMoto CForce 800 HO EPS (2024-)

2444.8192.1



EN Regular fasteners
DE Normale Befestigung
RU Штатный крепёж

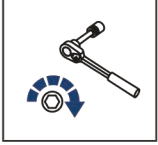

EN Regular fasteners
DE Normale Befestigung
RU Штатный крепёж



EN Screw a several turns
DE Mit wenigen Umdrehungen befestigen
RU Вкрутить на несколько оборотов



EN Loosen bolts
DE Bolzen lockern
RU Выкрутить на несколько оборотов

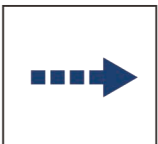

EN Movement Arrow
DE Bewegungsrichtung
RU Движение

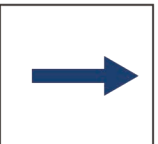



EN Location / Position Arrow
DE Anordnung / Positionsrichtung
RU Расположение

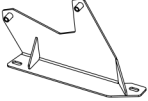
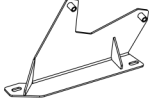
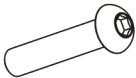
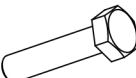

EN Screw Arrow
DE Drehrichtung
RU Поворот

	EN Ratchet DE Ratsche RU Трещётка		S - 10		HEX S - 4 S - 5		EN Wrench DE Schlüssel RU Гаечный ключ	10 mm
---	---	---	--------	---	-----------------------	---	--	-------

1		x1	2		x1	3		M6x30	x2	4		M6x30	x2	5		ø6	x4
----------	---	----	----------	---	----	----------	---	-------	----	----------	---	-------	----	----------	---	----	----

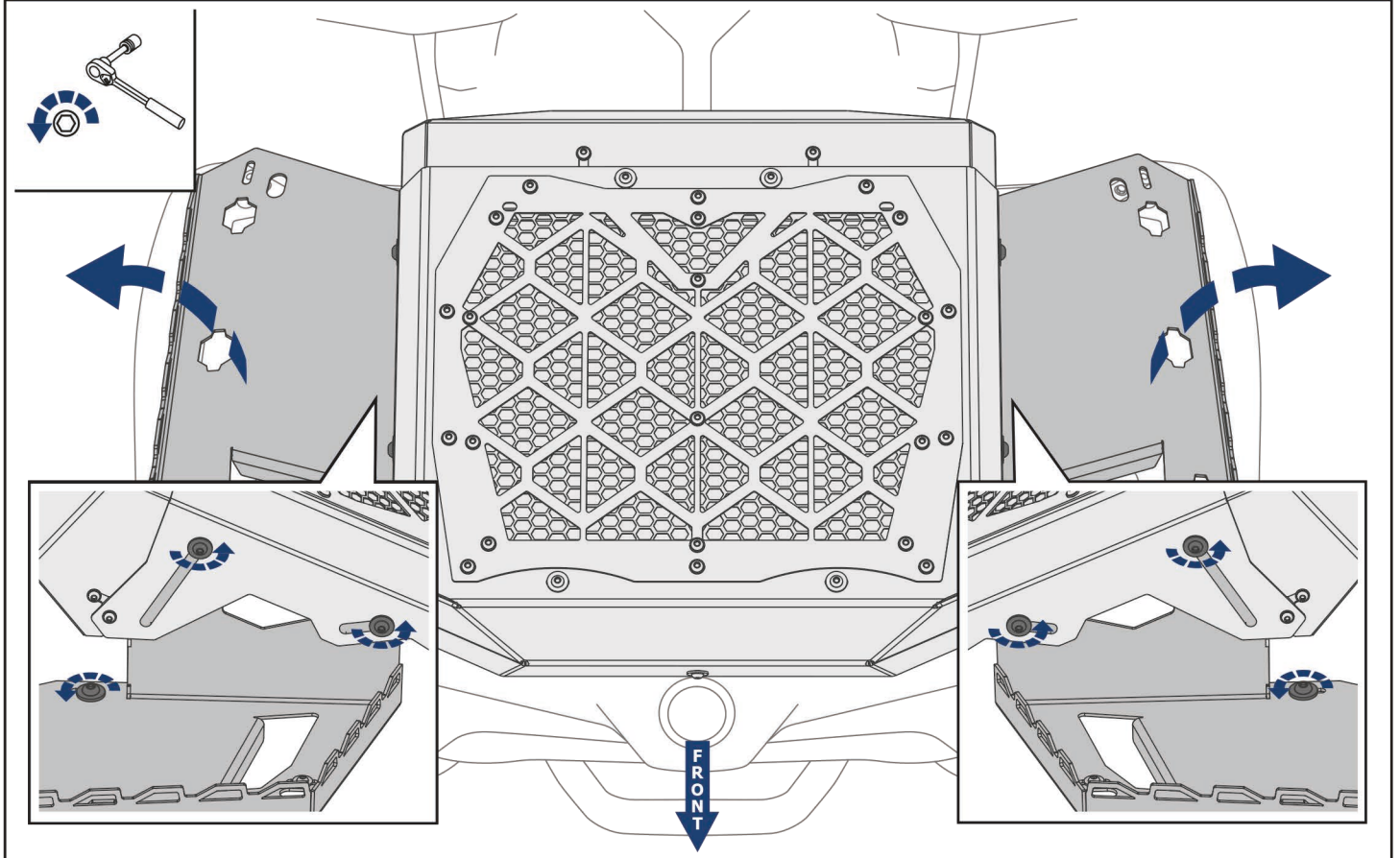
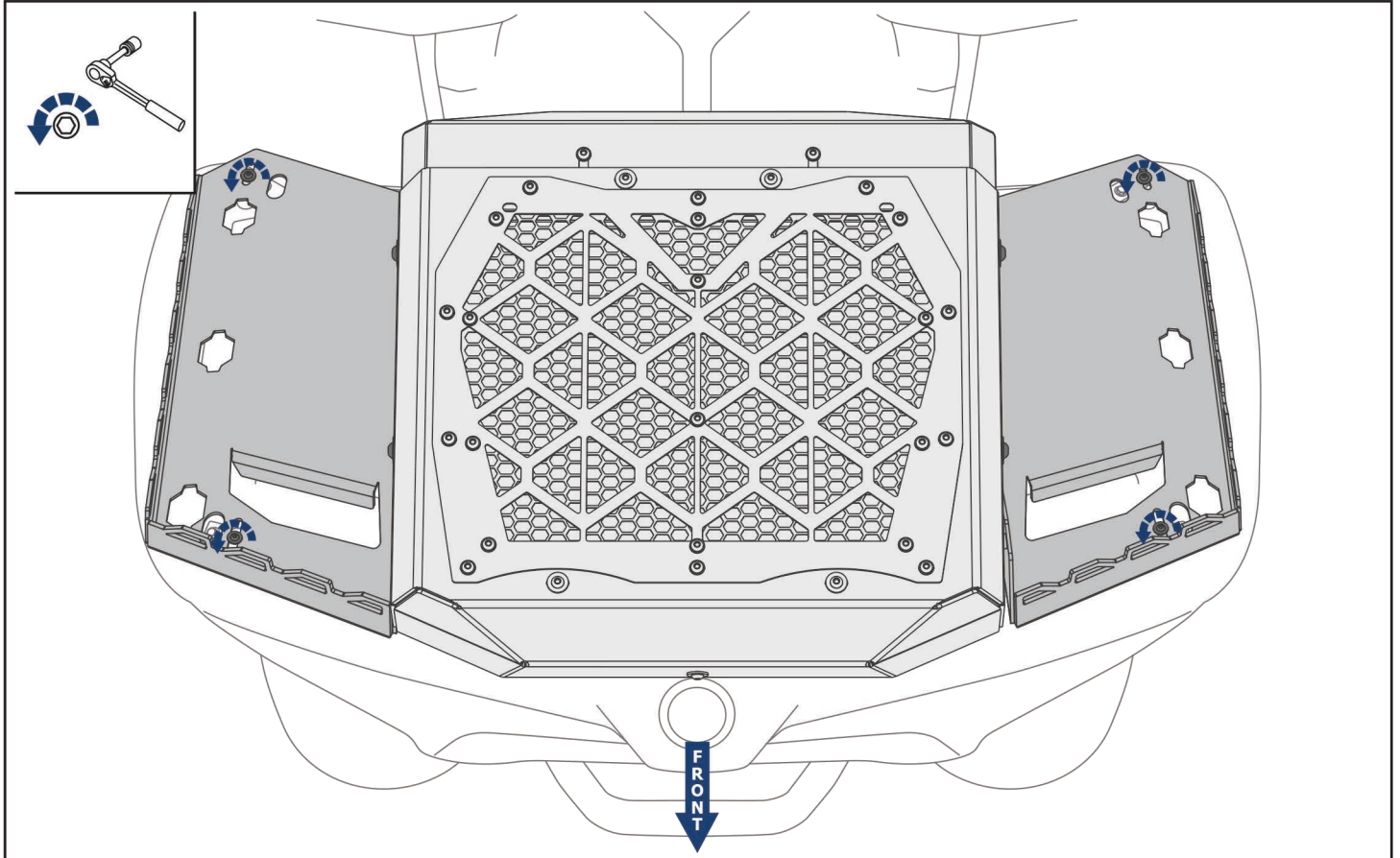

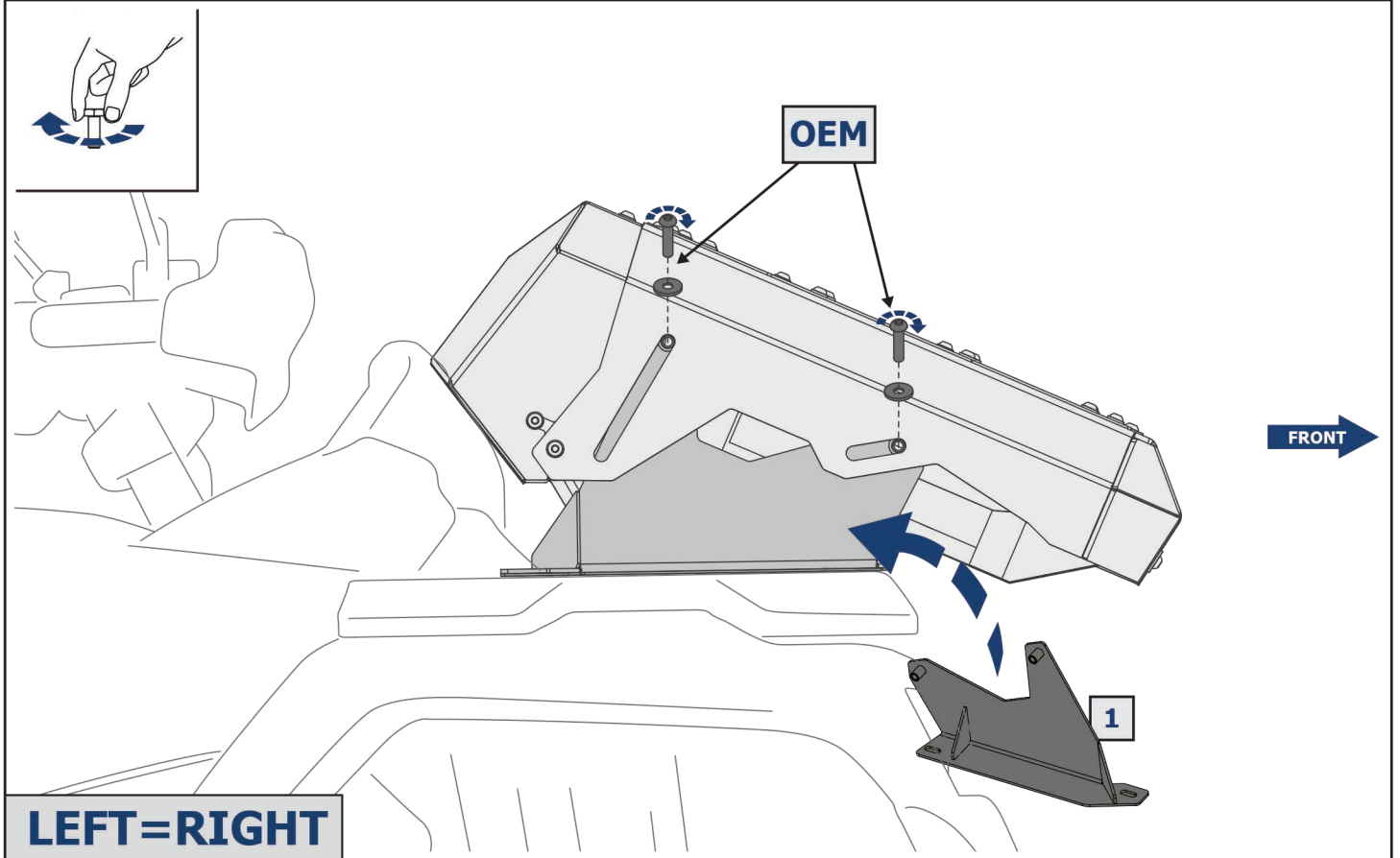
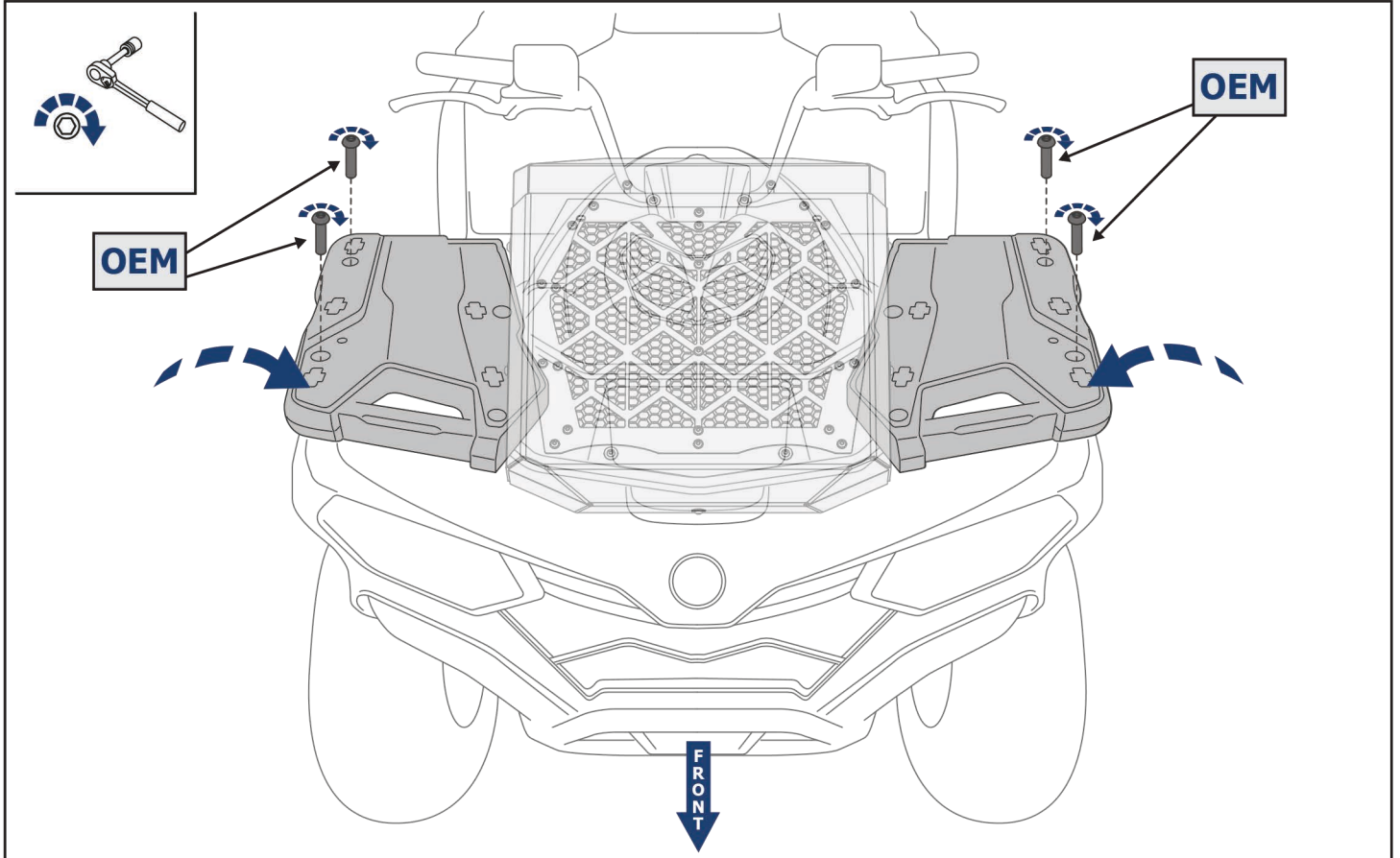

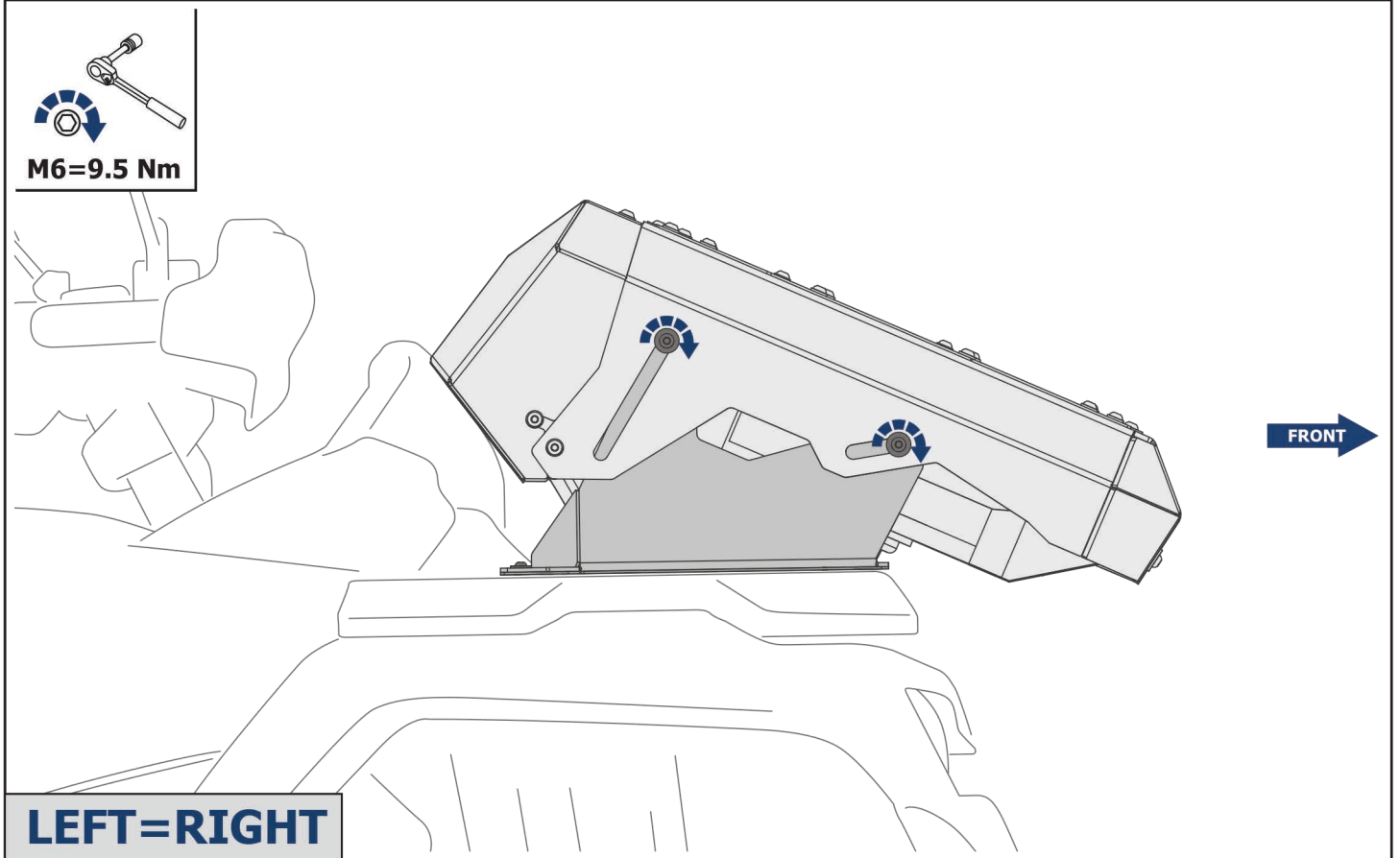
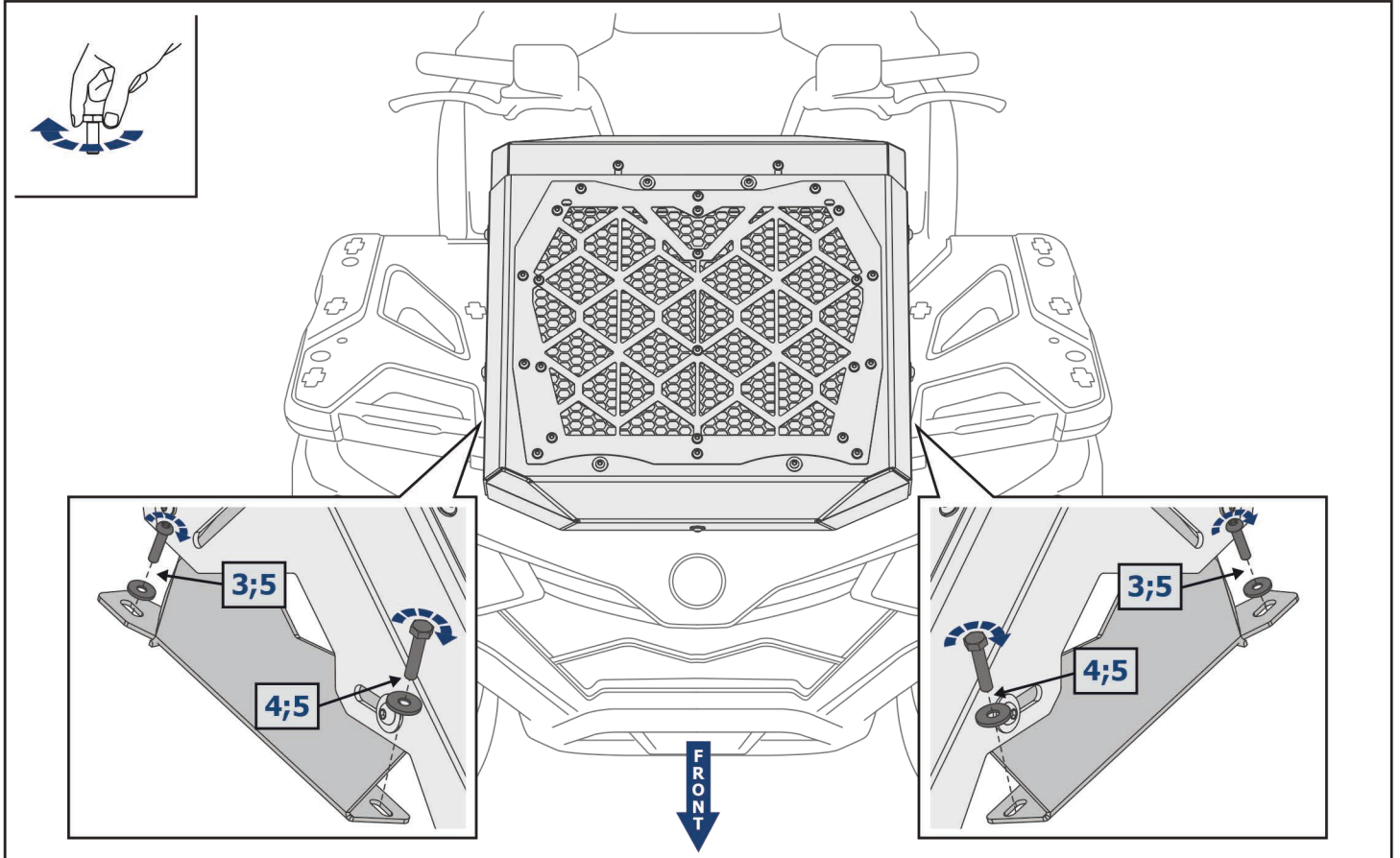

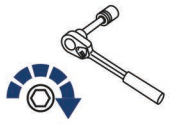

M6=9.5 Nm

