

EN BUMPER KIT INSTALLATION MANUAL

DE MONTAGEEINLEITUNG FÜR STOBFÄNGER-KIT

RU ИНСТРУКЦИЯ ПО УСТАНОВКЕ ПЕРЕДНЕГО БАМПЕРА



**For: BRP SKI-DOO SKANDIC SWT (2021-)**

2444.7299.1



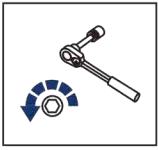

EN Regular fasteners  
DE Originale montageteile  
RU Штатный крепеж

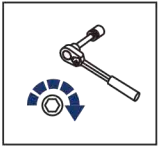

EN Regular fasteners  
DE Originale montageteile  
RU Штатный крепеж

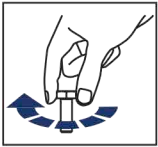

EN Screw a several turns  
DE Für wenigen Umdrehungen befestigen  
RU Вкрутить на несколько оборотов



EN Loosen bolts  
DE Bolzen lockern  
RU Выкрутить на несколько оборотов

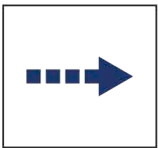

EN Movement Arrow  
DE Bewegungsrichtung  
RU Движение

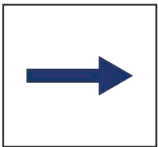

EN Location/Position Arrow  
DE Anordnung/Positionsrichtung  
RU Расположение



EN Screw Arrow  
DE Drehungsrichtung  
RU Поворот

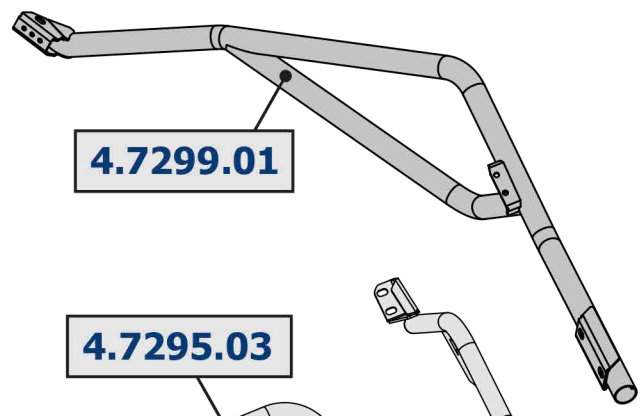
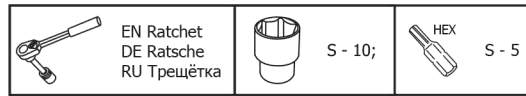

**4.7299.01**

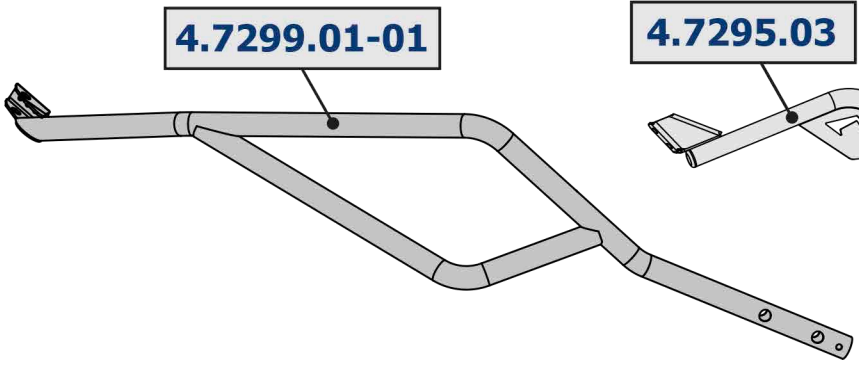



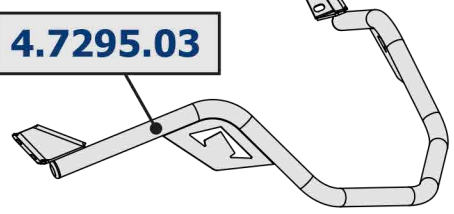





**4.7299.01-01**

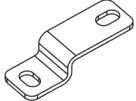
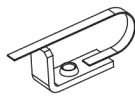

**4.7295.03**

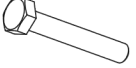
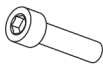
**4.7295.00.101**

**4.7295.02**

<b>1</b>  x4	<b>2</b>  x2	<b>3</b>  L=10mm x4	<b>4</b>  M6x16 x2	<b>5</b>  M6x16 x10	<b>6</b>  M6x20 x2
<b>7</b>  M6x50 x2	<b>8</b>  M6x20 x4	<b>9</b>  ø6 x12	<b>10</b>  ø6 x16	<b>11</b>  M6 x8	

