

EN REAR BUMPER KIT INSTALLATION MANUAL

DE MONTAGEEINLEITUNG FÜR STOBFÄNGER-KIT



For: CForce UForce 1000 EPS (2019-)

2444.6896.1



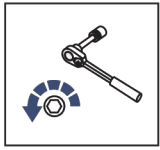

EN Regular fasteners
DE Originale montageile

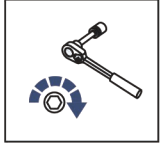

EN Regular fasteners
DE Originale montageile

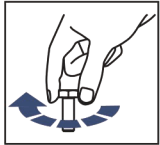

EN Screw a several turns
DE Für wenigen Umdrehungen befestigen

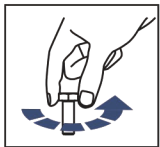

EN Loosen bolts
DE Bolzen lockern

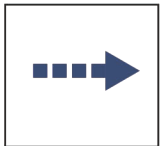

EN Movement Arrow
DE Bewegungsrichtung

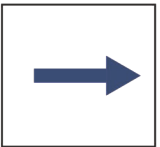





EN Location/Position Arrow
DE Anordnung/Positionsrichtung

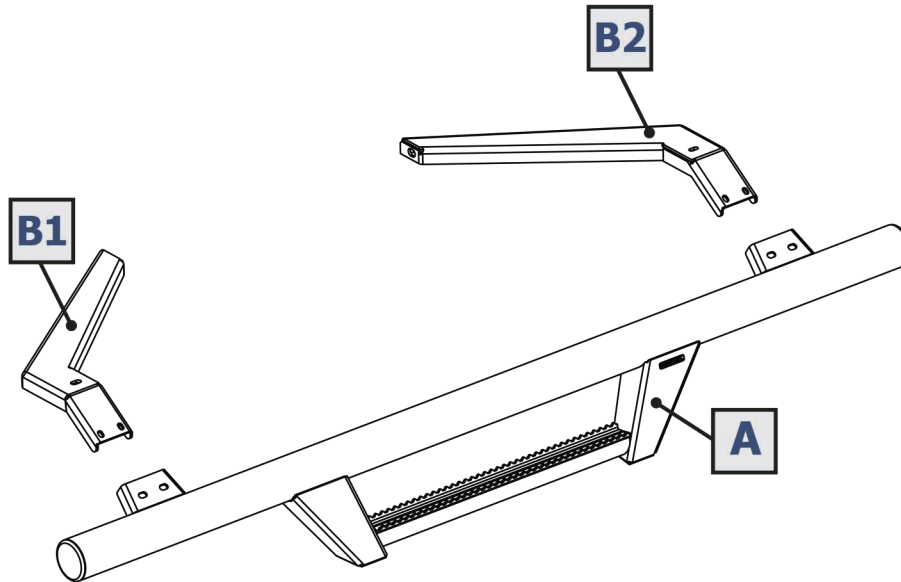

EN Screw Arrow
DE Drehungsrichtung

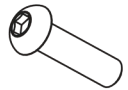
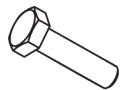
 EN Ratchet DE Ratsche	 S - 13	 TORX	 EN Office Knife DE Büromesser
--	--	--	--



1  M6x20 x4	2  M8x20 x2	3  Ø6 x8	4  Ø8 x2	5  M6 x4
---	---	--	--	--

When mount the rear bumper 2444.6896.1 on the UTV with installed tow hitch receiver the opening of the bed will be reduced on about 1.5 inches.

